

# RADIO CONSTRUCTOR

for the Radio and Television Enthusiast

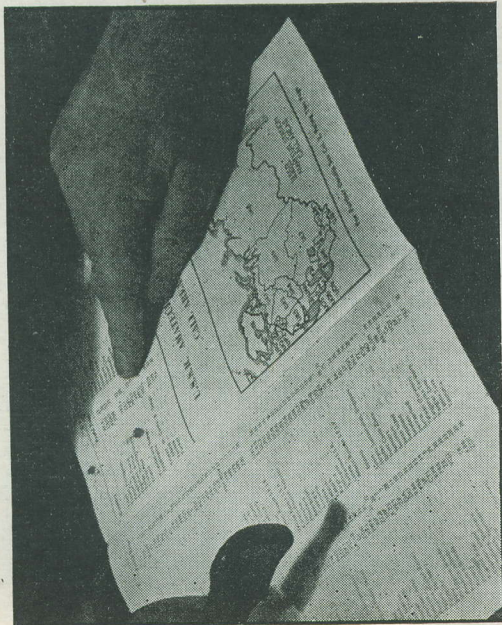

AT . . . .  
YOUR . . . .  
FINGERTIPS

All the information you need for the efficient operation of your station. Prefixes alphabetically and by Country, Zones, Maps, time factors, etc., etc., all for 1/6 in the 'OP-AID'. From your usual dealer or bookstall or direct from us at 1/8 post paid.

A.S.W.P., 57, MAIDA VALE, PADDINGTON, LONDON, W.9

TV

## TELEVISION NEWS

keeps you in the TV picture

FOR FREE  
SPECIMEN  
COPY  
POST THIS  
COUPON  
TODAY

Regular features include  
Free technical advice service • Summary of month's programmes in advance • New equipment and sets discussed • Latest books on TV reviewed • Authoritative articles on TV developments and techniques • Commentaries on past and future presentations • and many other important TV features.

To THE CIRCULATION MANAGER  
TELEVISION & GENERAL PRESS LIMITED  
119 BRENT STREET LONDON N.W.4.

Please send me free, and post free, a specimen copy of TELEVISION NEWS.

Name .....

Address .....

(Please use BLOCK CAPITALS)

Published by Amalgamated Short Wave Press Ltd. 57 Maida Vale, Paddington, London W.9 and Printed by A. Quick and Co. Ltd., Jackson Road, Clacton-on-Sea.

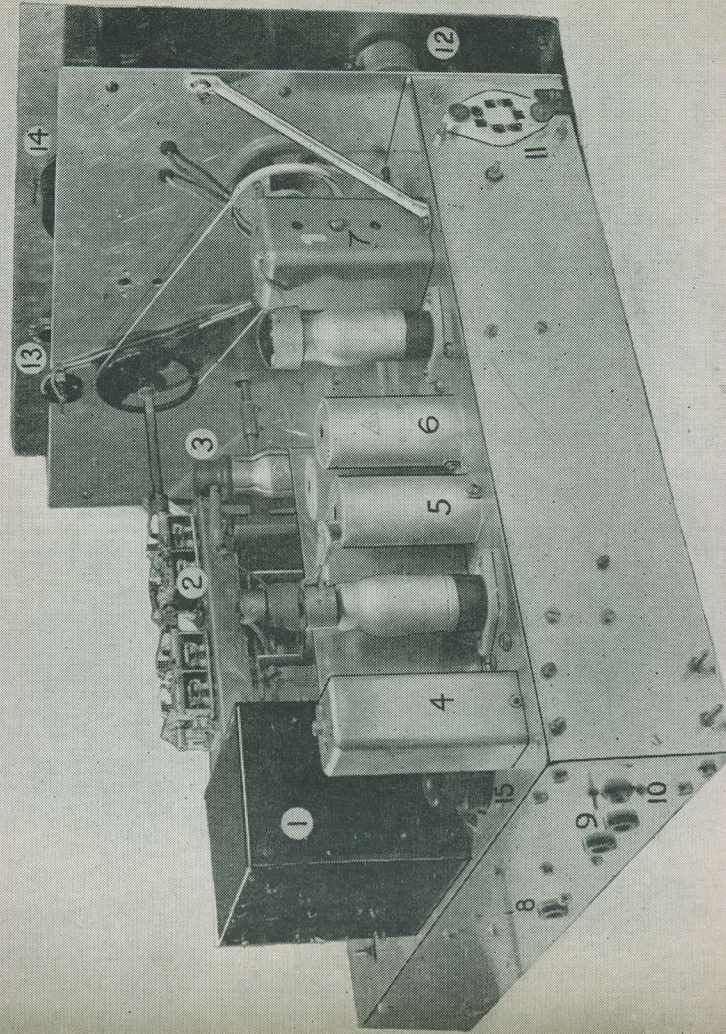

IN THIS ISSUE . . .

Communications Type Superhet • Inexpensive 7 Watt Amplifier • Economy Measures for All-Dry Receivers  
Useful Heater Transformer • TV Aerials • TV Coils  
Constant Companion Receiver, Part 3 • Keying Monitor  
Radio Miscellany • In Your Workshop

etc., etc.

# 13



**FOR ALL TYPES OF  
Television and VHF  
AERIAL INSTALLATIONS**

Maintenance to  
VHF Transmitting and  
Receiving Equipment  
Agents for B.M.C. Lightweight  
Television Aerials

TRADE ENQUIRIES INVITED  
Send for prices and details to:—

**5, PROBERT ROAD, BRIXTON  
LONDON, S.W.2.**

BRIXTON 7869

**Come to SMITH'S of EDGWARE ROAD  
the friendly shop for**

*We stock everything the constructor needs—our 25 years  
experience of handling radio parts and accessories enables us  
to select the best of the regular lines and the more useful  
items from the surplus market in:—*

Loudspeakers and Phones Valves and CR Tubes  
Transformers and Chokes Cabinets and Cases  
Meters & Test Equipment Capacitors and Resistors  
Pickups and Turntables Coils and Formers  
Switches and Dials Aerials and Sockets  
Metalwork and Bakelite Motors and Insulators  
Books and Tools Valve Holders and Cans  
Metal Rectifiers Wires and Cables  
Sieveing, Nuts and Bolts, Tags, Clips, Grommets and  
all other bits and pieces

**NOTHING TOO LARGE—  
NOTHING TOO SMALL**

*Everything you need under one roof.—Including all the parts  
specified for the popular "Viewmaster" Home-built  
Television, both London and Birmingham models.  
Send for list of our "Electro-Voice" range of Transformers  
and Chokes.—"As good as the best, yet cost little more  
than the cheapest!" (No general catalogue available).*

**H. L. SMITH & CO. LTD.**  
**287/9 Edgware Road, London, W.2**

Telephone: Paddington F891  
Hours 9 till 6 (Thursday 1 o'clock)  
Near Edgware Road Stations. Metropolitan and Bakerloo



**Radio Constructor**  
Vol. 4, No. 12 Annual Subscription 16/- July, 1951

Editorial and Advertising Offices—57, Maida Vale, Paddington,  
London, W.9  
Tel. CUNNINGHAM 6518.

Edited by G. W. G. OVERLAND, G2ATV

**CONTENTS**

Suggested Circuits: A Keying Monitor, by G. A. French	418
RC Quiz, conducted by W. Groome	419
Television Coils on Aladdin Formers, Pt. 3, by F. L. Bayliss, A.M.I.E.T.	420
Economy Measures for All-dry Receivers, by R. J. Caborn	423
Query Corner (Inexpensive Watt Amplifier)	427
Radio Miscellany, by Centre Tap	430
Useful Heater Transformer, by W. E. Thompson	432
Communications Type Superhet, by F. Willy Frenk	434
Practical Aerials, Pt. 11, by Aetherium	443
Constant Companion Receiver, Pt. 3, by J. R. Davies	445
In Your Workshop	450
From our Mailbag	452

**Editorial**

This magazine has now reached the end of its fourth year and, during this time, we think we can fairly claim that considerable progress has been made.

In our first Editorial, our policy was defined as "covering as wide a field as possible in the way of constructional features" and "including a certain amount of theoretical material in each issue, as this appears to be popular, but we shall confine such articles to those likely to be of use to the constructor". In short, we aimed at making this a practical magazine which would appeal to most tastes. When paper was made freely available we were enabled to add a further eight pages, which meant that we could give a greater variety in each issue in support of our policy.

That we are on the right lines is most clearly shown, we believe, by the fact that during the past four years our circulation has increased three-fold, and is still increasing steadily.

Until now, we have been able to maintain our original selling price, despite ever increasing costs, but, at last, we have to make a decision. We must either increase the selling price, or reduce the number of pages—alternatives which have already had to be faced by many of our contemporaries.

We have given this matter our most serious consideration. These days, pockets are apt to be light. On the other hand, if we reduce the number of pages we cannot give nearly as much variety as is necessary to meet the requirements of our readers. This last point is, we think, a most important one, and we reluctantly have to announce, therefore, that the selling price will be increased to 1s. 6d. as from the next issue

G2ATV.

**NOTICES**

THE CONTENTS of this magazine are strictly copyright and may not be reproduced without obtaining prior permission from the Editor. Opinions expressed by contributors are not necessarily those of the Editor or proprietors.

THE EDITOR invites original contributions on construction of radio subjects. All material used will be paid. Articles should be typewritten, and photographs should be clear and sharp. Diagrams need not be large or perfectly drawn, as our draughtsmen will redraw in most cases, but relevant information should be included. All MS must be accompanied by a stamped addressed envelope for reply or return. Each item must bear the sender's name and address.

COMPONENT REVIEW. Manufacturers, publishers, etc., are invited to submit samples or information of new products for review in this section.

ALL CORRESPONDENCE should be addressed to Radio Constructor, 57, Maida Vale Paddington, London W.9. Telephone: CUN. 6518.

**WHAT IS THE I.S.W.L.?**

- (1) The International Short Wave League is an organisation of short wave listeners, amateur transmitters, and others interested in short wave radio communication.
- (2) Its objects are to encourage, in every way possible, friendly intercourse and understanding between peoples of every country, through the medium of a common interest in their hobby.
- (3) Membership is open to anyone, of whatever race, creed, or colour, provided there is a genuine interest in short wave radio and a desire to further the aims of the League.
- (4) The membership fee consists of an annual subscription of 2s. 6d., or its equivalent. There is no entrance fee.
- (5) Contests, Set Listening Periods and Deductory Broadcasts are regularly arranged, in order to further the aims of the League.
- (6) Organisation consists of an HQ staff, Country, County and Town representatives, and local I.S.W.L. Groups. These latter are the essential units of I.S.W.L. activity, as they stimulate and keep together local I.S.W.L. members.
- (7) Many free services are available to help members to get the best out of their hobby. Amongst these is a QSL Bureau which is unique in that it handles both amateur and broadcast 'veries.'
- (8) A section of 'Short Wave News' is devoted each month to I.S.W.L. affairs, and carries news of contests and Group activities. The purchase of 'Short Wave News' is **NOT** a condition of membership.
- (9) The address of HQ is 57 Maida Vale, Paddington, London, W.9., and the telephone number is CUNNINGHAM 6518.

**IF YOU ARE A  
SHORT WAVE ENTHUSIAST  
—JOIN US NOW**

# Suggested CIRCUITS for the EXPERIMENTER

*The circuits presented in this series have been designed by G. A. FRENCH specially for the enthusiast who needs only a circuit and the essential relevant data.*

## No. 8 A Keying Monitor

Although this circuit is designed mainly as a monitor for amateur-built transmitters it is capable of being used for many other purposes, where the switching of AF amplification by means of an RF signal is required. It could, for instance, provide a useful method of silencing a sensitive receiver which is not tuned to an actual carrier; (in such a case the value of C3 would have to be increased). As a monitor it has the advantage that the AF in the headphones is controlled by the transmitter output itself and not by subsidiary key circuits; thus giving a more reliable idea of what is heard at the distant receiver.

### The Operation of the Circuit

In its normal state the triode is overbiased, this being done by choosing an appropriate grid bias voltage with the GB-2 tap. This negative voltage will cause the diode V1 to conduct and so the bias actually applied to the valve will be approximately half of that chosen, the voltage drop being occasioned by the potentiometer R1, R2. The grid bias tap used should be just sufficient to ensure cut-off, thus preventing the triode from amplifying the output of the separate AF oscillator

which is fed to its grid via C3. The GB-1 tapping is taken to a point which corresponds to slightly more than the usual bias voltage for the particular type of triode which is being used.

When an RF input is applied to the tuned circuit, V1 immediately rectifies, thus applying a positive voltage (relative to chassis) to R1. This voltage causes the negative bias on the valve to be reduced or removed, allowing it to amplify the AF oscillator, whose note is then heard in the headphones. As it would be difficult to regulate the RF voltages appearing across the tuned circuit, the input is made such that the voltage obtained from the rectified RF is too large and would cause the grid of V3 to become positive with respect to its cathode (resulting, in practice, with "clicky" monitoring). However, when the positive voltage at the grid of V3 rises above its usual grid bias value, V2 conducts and provides an effective short-circuit to any increasing grid voltages.

### Practical Points.

Although the circuit shown here is perfectly capable of working as it stands, some experimenters may care to make a few alterations to meet different conditions. For instance, the headphones could be replaced by a transformer, the secondary of which could be permanently connected to the receiver output terminals, thus obviating any headphone switching. Similarly, the grid bias battery could be dispensed with, using instead a rectified negative supply from the mains and employing pre-set potentiometers for the tapings.

When used as a monitor, only a very loose coupling to the transmitter should be needed. This may consist of a short length of wire mounted near the aerial terminal or near the output tank circuit.

### DESPITE THE FACT

that we are now printing and distributing many more copies of this magazine, we are still receiving letters from readers informing us that they have difficulty in obtaining regular copies. If details are sent to us, then we can take up the matter with the people concerned. Should this prove ineffective, then we shall be glad to supply copies direct, on either 6 or 12 month subscriptions.

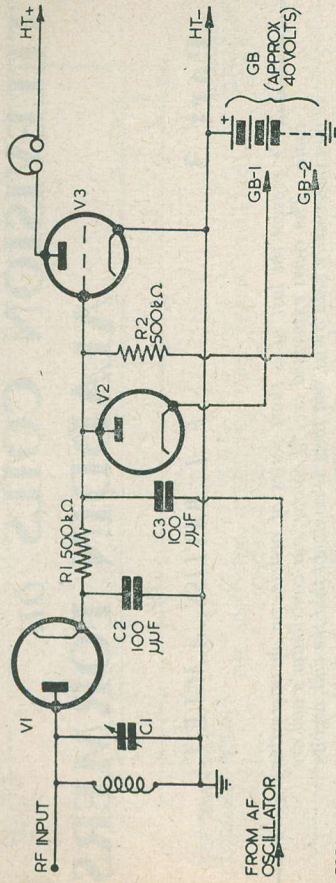

C353

*Circuit of the Keying Monitor.*

## “RADIO CONSTRUCTOR” QUIZ

*Conducted by W. Groome*

(1) It is surprising how easily an experienced constructor can be tripped up by an elementary job which he could have managed in his schooldays. Mr. Brain built his small boy a neat little crystal set, and bought a pair of surplus headphones to go with it. But, although the wiring was correct and the crystal itself perfect, the result on a good aerial was—silence. Where had he slipped up?

(2) The tragic death of a child, recently, through contact with an AC/DC television receiver emphasises the need for precautions in the building and use of this class of radio and TV receiver. These rules have been stressed before in this column and elsewhere in ‘Radio Constructor’, and we now invite you to re-cap and check your list with that given on page 426.

(3) Third harmonic distortion is balanced out in push-pull output stages. Right or wrong?

(4) What is the purpose of the cathode by-pass capacitor?

(5) Decoupling is generally unnecessary in a two-stage AF amplifier. Right or wrong?

(6) In what way can a TV receiver cause interference with nearby radio sets?

*Answers on Page 426.*

## LEARNING MORSE

There are some short wave listeners who miss a great deal of the interest in their hobby because they never acquire the ability to read morse code.

Even the SW broadcast enthusiast would be well advised to spend a portion of his time in studying the code, as he will find the call signs of commercial stations very useful as markers for frequency checking. We know that many SWL's say they find all the interest they need in short wave listening without wanting to take up amateur transmitting; but we think it imperative that the SWL who takes his hobby seriously should acquire at least a working knowledge of morse.

One of the most renowned systems is, of course, the Candler System, and readers will be interested in a “Special Course” which has just been devised by this organisation for short wave listeners and those wishing to take the GPO Morse Test.

The Course includes all the training necessary for the average student to pass the Test associated with the Radio Amateurs Examination and is, as we have indicated, an ideal one for the listener also. Readers should write to the Candler System Co., 52b Abingdon Road, Kensington, W.8., asking for the Candler “Book of Facts”, and stating that they are interested in the “Special Course” referred to in this periodical.

# TELEVISION COILS on ALADDIN FORMERS

Part 3 by F. L. BAYLISS, A.M.I.E.T.

We present the last of a short series of articles on an interesting topic. The views expressed are, of course, our contributor's and are not necessarily held by us, but there is no doubt that the coil, and its circuit, plays a most important part in any television, and this series will have served its purpose if it causes the television enthusiast to devote some thought to this subject.

### The Vision Filter

THE filter associated with the vision diode demodulator should give complete and efficient eradication of residual RF in the diode cathode circuit, yet leave the vision frequencies quite unmarred.

It is a good plan to assemble and wire the unit as a whole prior to fitting it in the receiver and, using the winding method shown in Fig. 7, this may easily be carried out.

L1 is the filter choke, consisting of 100 turns 40 swg enamelled wire, close wound at the bottom of the coil former.

L2, in conjunction with R1, forms the diode load, and this choke, consisting of 150 turns 36 swg enamelled wire, is wound between the two cardboard spacers as shown.

If the coil is to be mounted separately, and not in the pack to be described, bring the wire-ends out to tags at the top of the coil formers, and wire also resistors R1, R2 and

capacitors C1, C2 across these tags. Make sure to get the connections right, though these are in accordance with Fig. 6, and it will be noted that the filter diode load and video valve grid leak are all shown leaving no further connections to be made to the video valve.

It should be noted that the iron-dust core is not required for these chokes and should be omitted.

### A Vision Coil Pack

The advantage of assembling the coils and chokes into one complete coil pack is the obvious one that wiring the receiver may be done in stages. The chassis wiring, heater and cathode circuits comprise stage one. Next, the coil pack may be assembled, and the anode and screen decoupling resistors and capacitors together with damping and stabilising resistors may all be wired inside the coil compartments.

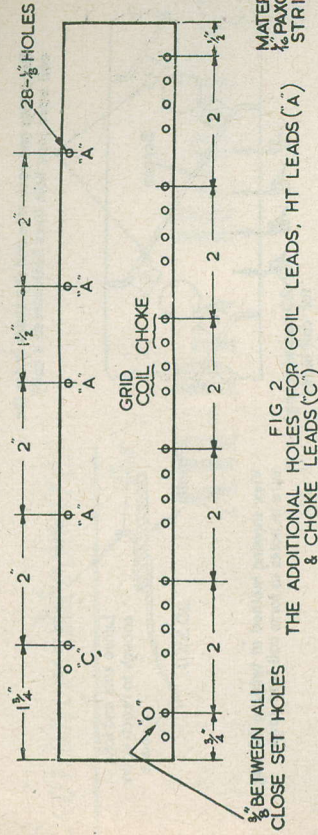

C-355

Finally, the pack is placed into position in the receiver, and the coil tags (Fig. 4) covered with sleeving and soldered to their respective valveholder tags.

### The Base Strip

The base consists of a strip of paxolin 1 1/4" x 1 3/8" x 1/16", drilled as shown in Figs. 1 and 2.

The positions will be occupied by coils as follows:-

- Position 1, Aerial Coil.
- Position 2, 3, 4 Intervalve choke-fed tuned-grid coils.
- Position 4 (rear), Rejectors, inductively coupled.
- Position 6 (front), The choke filter.
- Position 6 (rear), Only used when the chokes L1, L2 are wound upon separate formers.

The drilling centres of 2" between coils allows this distance to be adopted when spacing the valveholders; the coils will thus be immediately opposite their relevant valves, and the final connections from coil pack to valveholders need only be an inch or so.

The 'A' holes enable wire tags for HT connections to be convenient in positions 2 to 5, and these leads may be strapped (preferably in screened wire) along the underside of the strip.

When wiring the coil leads to the 20 swg wire tags, connect the grid-coil pair and choke pair to the tags as shown in Position 3 on Fig. 2.

(When this coil pack is used, the small paxolin tag panels at the top of the coil formers, Fig. 7 and previous diagrams, are not required; the wires are brought out direct to the strip tags.)

**Screens**  
The intermediate and end screens are made of light gauge aluminium cut, drilled and folded as shown in Fig. 3. The fixing lugs of both types of screen are bent in opposite directions.

Thus, the lugs of the diagonal screens fit one under each of two adjacent coil formers (Fig. 4) whilst the centre lug or flange of the end screen bolts underneath the end of the paxolin strip, leaving the two outer flanges bent outwards for bolting to the chassis (Fig. 5)

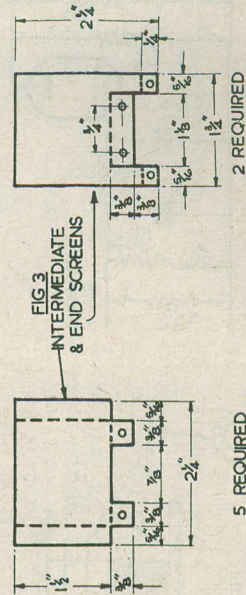

5 REQUIRED

MATERIAL LIGHT GAUGE ALUMINIUM

C-356

# TELEVISION COILS on ALADDIN FORMERS

Part 3 by F. L. BAYLISS, A.M.I.E.T.

### The Vision Filter

THE filter associated with the vision diode demodulator should give complete and efficient eradication of residual RF in the diode cathode circuit, yet leave the vision frequencies quite unmarred.

It is a good plan to assemble and wire the unit as a whole prior to fitting it in the receiver and, using the winding method shown in Fig. 7, this may easily be carried out.

L1 is the filter choke, consisting of 100 turns 40 swg enamelled wire, close wound at the bottom of the coil former.

L2, in conjunction with R1, forms the diode load, and this choke, consisting of 150 turns 36 swg enamelled wire, is wound between the two cardboard spacers as shown.

If the coil is to be mounted separately, and not in the pack to be described, bring the wire-ends out to tags at the top of the coil formers, and wire also resistors R1, R2 and

capacitors C1, C2 across these tags. Make sure to get the connections right, though these are in accordance with Fig. 6, and it will be noted that the filter diode load and video valve grid leak are all shown leaving no further connections to be made to the video valve.

It should be noted that the iron-dust core is not required for these chokes and should be omitted.

### A Vision Coil Pack

The advantage of assembling the coils and chokes into one complete coil pack is the obvious one that wiring the receiver may be done in stages. The chassis wiring, heater and cathode circuits comprise stage one. Next, the coil pack may be assembled, and the anode and screen decoupling resistors and capacitors together with damping and stabilising resistors may all be wired inside the coil compartments.

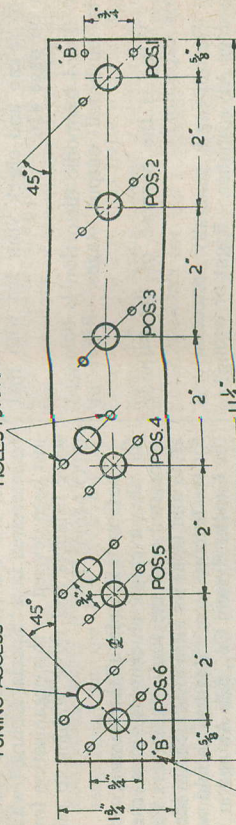
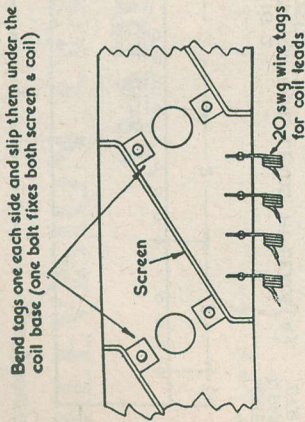

FIG 1 DRILLING DATA FOR THE FORMERS

THE 'B' HOLES ARE FOR END SCREENS

C-354



Solder coil lead to here

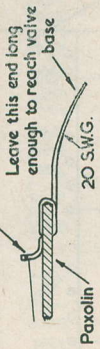

View showing method of twisting 20 swg wire in holes to form coil lead tags.

FIG. 4. PORTION OF STRIP SHOWING METHOD OF FIXING INTERMEDIATE SCREENS.

C357

lower end, and it is a sound plan to drill chassis holes to suit, so that tuning may be effected with a minimum of trouble.

Note the outer coiled ends of the 20 swg tags in Fig. 4. These may be uncoiled as required and, with sleeving slipped over the required length, be connected directly to the valveholders.

Although particulars for a similar coil pack for the sound receiver have not been given, such a pack may be constructed in a similar manner. In this case, the length of the strip will be determined by the number of RF stages, and the holes for the rejectors may be omitted or, rather, replaced by slightly wider spaced holes for the two-coil transformers. However, there is ample width on the paxolin strip to enable the pairs of coils to be correctly spaced and to allow, even, variation of such spacing along the two or three stages used.

Finally (and once again), the iron-dust core normally provided with the Aladdin formers is *not used in the vision filter-and-load choke.*

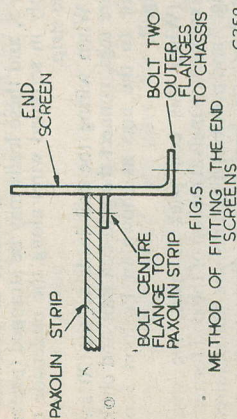

FIG. 5. METHOD OF FITTING THE END OF SCREENS.

C358

Note that the coil formers are bolted on top of the screen flanges, one 6BA bolt serving to secure formers, screen and paxolin in each case, thus leaving a gap under the coil formers through which the coil leads may be passed after having been threaded through the tiny holes in the base of the former.

**General Notes**

The  $\frac{3}{8}$ " holes in the paxolin strip allow access to the core from either the upper or

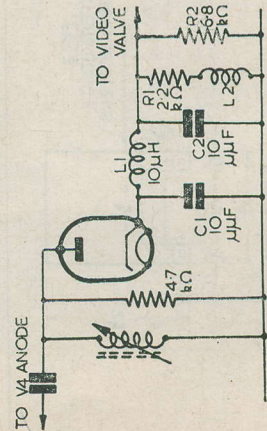

FIG. 6. THE VISION RF FILTER.

C359

# Economy Measures for

# All-Dry Receivers

By R. J. CABORN

**N**OW that the warm days have been with us for some time, the portable radio has come into prominence in many domestic circles. This is particularly true, of course, of the all-dry and the "personal" portable, as both these sets enjoy the advantages of being completely self-contained and of using batteries which may be easily replaced without any risk of mess or damage.

Unfortunately, these all-dry receivers have one disadvantage: a high cost of upkeep. Although manufacturers do their best to utilize circuits which entail minimum current drain, the batteries still wear out; and it is an irritating, but true, fact that the smaller the battery, the greater its price and the shorter its life.

In this article the writer points out methods of obtaining a longer life from these batteries; and touches also upon arrangements which may be made to take advantage of external supplies, should the receiver be operated at home and not as a portable.

**The "Life" of the Battery**

To obtain a clear picture of how we may extend the apparent "life" of the batteries let us first of all analyse the losses in receiver performance which occur as the batteries wear out with normal use.

The first thing to note is that the internal resistance of the batteries (particularly that of the HT battery) increases with use. Amongst other things, this increase can cause reduced output owing to the fact that the output valve is not feeding into an impedance represented by the speaker transformer primary alone, but into a load given by the primary and a series resistor equal to the internal resistance of the battery itself. See Fig. 1. The effect of the increased internal resistance is most noticeable in the output anode circuit, since this deals more with changes in current than do the other anode circuits in the set.

Secondly, the increase in internal resistance of the HT supply has the effect of introducing instability, insofar as the anode circuits become badly decoupled to chassis; the result being either reduced performance or actual oscillations.

In the third place, low HT voltage may cause the oscillator to cease functioning on one or more wavebands. This occurs fairly readily in some cases, giving us a receiver which is still capable of excellent results at the reduced battery voltages existing, were it not for the fact that the oscillator had stopped working.

Fourthly, the LT circuits should be considered. Although there is not really much that one may do to reduce LT consumption, one or two hints are, nevertheless, given below.

Fifthly and finally, there is the apparent reduction in battery life given by the fact that the particular receiver is faulty, due to incorrect alignment, unserviceable valves and

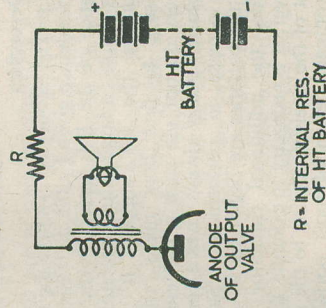

C377

Fig. 1: Illustrating how the internal resistance of the HT battery may reduce the efficiency of the output anode circuit.

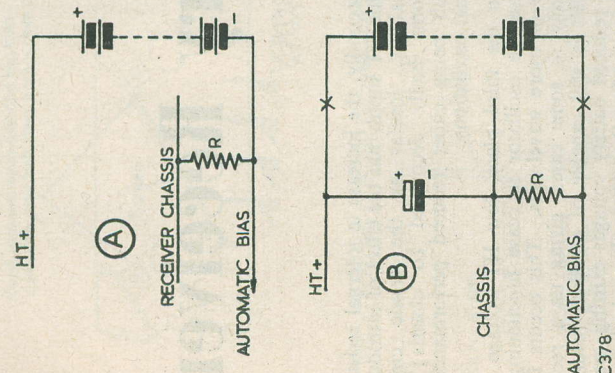

C378

Fig. 2 (a) : The method used in many receivers to supply HT and automatic bias.

Fig. 2 (b) : How the HT supply may be decoupled (The crosses mark alternative points at which the battery may be switched).

so on. Obviously enough, in this case, the set should be overhauled, whereupon it would be able to work properly over a wider range of battery voltages than occurred previously.

#### HT Decoupling

We picked as our first example the reduction in performance given by the increased internal resistance of the HT battery. The cure for this is simple: a large value capacitor connected across the HT supply. It is really surprising to find how many commercial receivers do not use such a capacitor, when its inclusion nearly always gives a very noticeable increase in performance, particularly when the batteries are beginning to wear.

Before the additional capacitor is fitted, however, it is necessary to examine the circuit layout of the receiver. Owing to the small size and compact design of most portables it is usually best to use an electrolytic component, and this type of capacitor cannot of course be left permanently connected, as the slight current drain it causes would shorten the life of the HT battery. Also, it would be advi-

able to give a little thought as to how it may be connected, since the HT negative line is seldom taken directly to chassis.

Fig. 2 (a) shows a popular circuit in which the negative terminal of the HT battery is connected to chassis via a resistor R, in order to give a source of automatic bias. The HT supply is decoupled in a case of this sort simply by connecting the additional capacitor as shown in Fig. 2 (b); that is, between HT positive and chassis.

At first sight, the circuit of Fig. 2 (b) may not appear to give an effective solution to the problem owing to the fact that the resistor R is still in circuit and may act as a common load for the HT returns of all the stages in the receiver, thereby causing instability or negative feedback to the output stage. In practice, these faults do not occur, since the returns of the various anode loads are taken, via the additional capacitor, to chassis, and not to HT negative. As the cathodes of the valves are also taken to chassis all amplification in the receiver is carried out between the HT positive line and chassis, the additional capacitor ensuring that there is an easy path between these points and that no signal voltages appear elsewhere. The resistor R therefore acts only as a DC dropping resistor, and no signal voltages are built up across it.

The same holds true for almost every type of all-dry receiver in which HT decoupling is required, it being effected simply by connecting the capacitor between HT positive and chassis.<sup>1</sup>

As was mentioned before, the additional capacitor used for the decoupling is electrolytic, and it should have a value of 5 to 10 $\mu$ F at around 150 working volts. A capacitor of this size will be quite small in size and it should be able to fit into all but the most compact of receivers. There is no need to worry about its positioning on the chassis as it may be mounted at any convenient point. The connecting leads need not be kept very short; although it is advisable to run them over the most direct route.

The inclusion of the extra decoupling capacitor will, of course, necessitate switching off the HT battery when the receiver is not in use. The HT circuit may be broken in either lead from the battery (as shown at the points marked with a cross in Fig. 2 (b)) and this may incur a little rewiring at the on-off switch of the receiver.

Apart from increasing the efficiency of the

1. This is not necessarily true for AC/DC/Battery sets which may utilise a different method of decoupling. Usually, however, these sets have electrolytic capacitors connected permanently across the HT supply, whether they are switched to "mains" or "battery".

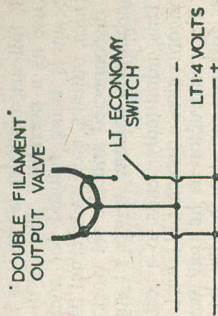

C379

Fig. 3 : A suggested method for effecting an economy in LT current.

grid coupling capacitor. If either of these are increased, it should be found possible to maintain oscillations at lower battery voltages. If, however, the values are increased too much, the oscillator is liable to "squeg" on the resumption of full voltages. Squegging will be evident as a strong hiss either all over or on part of one of the bands.

#### The LT Supply

As was stated above, there is really very little that can be done to increase the life of the LT battery. When the receiver is being used constantly the LT battery may polarise fairly rapidly and give an apparently shortened life. In this case, it is often worth while leaving the battery in a fairly warm place (room temperature is quite sufficient) for a fortnight or so whilst another battery is used in its place. It may then be found that the first battery will have become depolarised and should be capable of a further lease of life. (The old "dodge" of popping a worn-out battery in the oven (!) or near the fire can hardly be recommended).

A small saving may be effected if a double filament valve (such as the 3Q5) is used in the output stage. An "economy" switch could then be fitted as shown in Fig. 3, it being used to cut out one of the filaments at times when the set is only required to play quietly. However, the use of this switch may cause the life of the filament always in use to be slightly shortened, since it carries all the cathode current when the switch is in the "economy" position. Nevertheless, with the average four valve superhet, a saving of 20% of the total LT consumption can be given by this means.

#### Using External Batteries

A considerable saving in the cost of running the smaller type of all-dry portable can be obtained if the receiver is connected to exter-

output stage, the additional capacitor will also, of course, remove any tendency towards instability which may be caused by increases in the internal resistance of the HT battery.

It must also be remembered that the use of the capacitor does not, of course, increase the life of the HT battery; instead, it enables the receiver to work when this has dropped to a lower voltage (very often, a *much* lower voltage) than would otherwise be the case.

#### The Oscillator

The effect of reduced HT and LT voltage sometimes causes the frequency changer oscillator to stop working, whilst the rest of the set is still capable of giving good results. The symptoms of oscillator failure are given by the fact that the set suddenly goes "dead", although the rest of the receiver seems quite "lively". Increasing the supply voltages will usually cause the receiver to start working again.

This failure usually points to a faulty oscillator valve and this should be replaced before anything else is suspected. 1.4 volt frequency changers are notoriously "fussy" as regards oscillator voltages and they wear out fairly quickly.

Cessation of oscillations often occurs on one band only. This does not necessarily point to a failure in that particular band; (although, of course, the wave change switch and the appropriate coils and components should be examined for faults). Instead, it often means that the oscillator is *just* managing to work on the other wave bands and that the whole circuit, or the valve itself, is at fault.

If replacement of the oscillator valve does not remove the trouble, and the coils, wave-change switch and so on are above reproach, the next thing to look for are faults of a general nature. The connections to the oscillator should be examined as, also, should the insulation of the appropriate components. To take an example, it only needs a small amount of dirt on the oscillator valveholder to cause losses sufficiently large to stop oscillation. Cleaning the valveholder, the wave change switch and any other oscillator components with carbon tetrachloride often removes dirt and grease which is invisible to the eye. It must be remembered that the value of the oscillator grid leak in these sets is often as high as 0.25 to 0.5 Meg $\Omega$ , so small leaks caused by dirt, etc., can therefore have very noticeable effects.

Occasionally, although the writer does not necessarily recommend this course, the performance of the oscillator may be improved by altering the values of the grid leak and

nal, full-size batteries when it is not actually in use as a portable. That is to say, unless the set is being utilised for such things as picnics, outings, etc., its internal batteries may be disconnected and the set worked from an external and cheaper source of supply.

This, admittedly, leads to a certain amount of inconvenience, which will have to be reduced by the constructor as he may best think fit. For instance, it can hardly be considered worth while fiddling with the plugs and sockets of the internal batteries every time such a change is required; and so a little ingenuity may be required.

A very neat way of effecting the change-over is given by fitting a small socket to the back of the set, in company with a switch which connects the receiver either to the internal batteries or to the socket. When the set is used in the home a plug connected to the appropriate external supply is fitted to the socket and the switch is set to "external".

Should the set be wanted in its portable form the switch is returned to "internal".

A full-size 120 or 90 volt HT battery, or a mains eliminator may be used for the external HT supply. The LT voltage could be given by a really heavy 1.5 volt battery (such as three or four "bell" batteries in parallel) or, much cheaper, by a two-volt accumulator in series with the appropriate value of resistance. If these external supplies were fitted in a box or cupboard with a neat connecting wire leading to the plug for the back of the receiver, they would not detract from the appearance of the room in which they were installed; and they would enhance the usefulness of the portable receiver. They would also give rise to a considerable economy in its running.

1. The value of resistance used should be capable of dropping the 2 volts supplied by the accumulator to 1.4 and not 1.5 volts. Thus a receiver whose LT connection is 250 mA would require a series resistor equal to  $\frac{2-1.4}{0.25}$  ohms, that is, 2.4 ohms.

## ANSWERS TO QUIZ

- Mr. Brain forgot to check the resistance of the headphones which, like many of these ex-Service types, were low impedance and quite unsuitable for a crystal set without a matching transformer.
- Switch both mains leads. Use three-pin plugs to ensure correct connection to the mains, i.e., neutral lead to chassis. Enclose the set completely in a cabinet of insulating material, with no trace of metal outside. Avoid metallic escutcheons and loudspeaker grilles. Use bushed knobs so that no bare shaft is exposed. Grub screws should be driven deeply beneath the surface of the knobs and the holes filled with hard wax to cover the screwheads. Chassis fixing bolts through the bottom of the cabinet should have the heads insulated in some manner. There should be no direct connection from chassis to earth. The aerial coil must be isolated from chassis and from the grid coil, or the aerial connected via a small capacitor (mica) of adequate voltage rating. Neither conductor of a co-axial or twin-feeder dipole feeder should be connected to chassis. The output transformer secondary, and any extension speaker leads, to be isolated from chassis. (Voice-coil negative feedback connections can cause

extension leads to be "live"). Remember that the chassis and everything connected to it may be "live"—even when the switch is in the "off" position.

(3) Wrong. Only second-harmonic is eliminated in the output stages, which is unfortunate because third-harmonic is the most offensive to the ear.

(4) To prevent loss of gain through negative current feedback, by bypassing feedback voltages set up across the cathode resistor. At audio frequencies, it also bypasses any hum which may be developed across the same resistor.

(5) Right. The signals at the anodes are in opposite phase and no instability is likely. This is only true so long as the amplifier is used alone; a pre-amplifier would need to be well decoupled before being used with the amplifier.

(6) Generally the line scan amplifier, line output transformer, and flyback EHT sections are responsible for radiation, which can influence broadcast receivers within a short distance. Such interference does not seem to occur frequently, and it is easily cured by attention to screening.

## QUERY CORNER

### A "Radio Constructor" Service for Readers

#### An Inexpensive 7 Watt Amplifier

*I would like to construct an inexpensive amplifier which is capable of giving good reproduction from gramophone records at a fairly high volume level. I intend to build the amplifier into a playing desk which is to be used in a small hall; the speaker can if necessary be housed in a separate box. Your suggestions on a suitable circuit would be appreciated.*  
D. Craven, Bristol.

We have on occasions published circuit diagrams of audio amplifiers which are capable of an output of between 5 and 10 watts, but these have in the main been of the AC type having bulky mains transformers and push-

pull output stages. A complete equipment of this type is relatively costly to construct, and in an effort to produce results which are comparable, but at considerably less cost, the circuit shown in figure 1 was devised. The output power which can be obtained from this amplifier will depend upon the mains supply voltage to which it is connected, but it should be between 6 and 9 watts, hence we feel justified in conservatively labelling it a 7 watt equipment. The quality of reproduction is most satisfactory and, although it will probably not meet the requirements of those enthusiasts who can tolerate nothing less than push-pull output triodes in their amplifiers, it should certainly provide a very good second best in reproduction. The over-

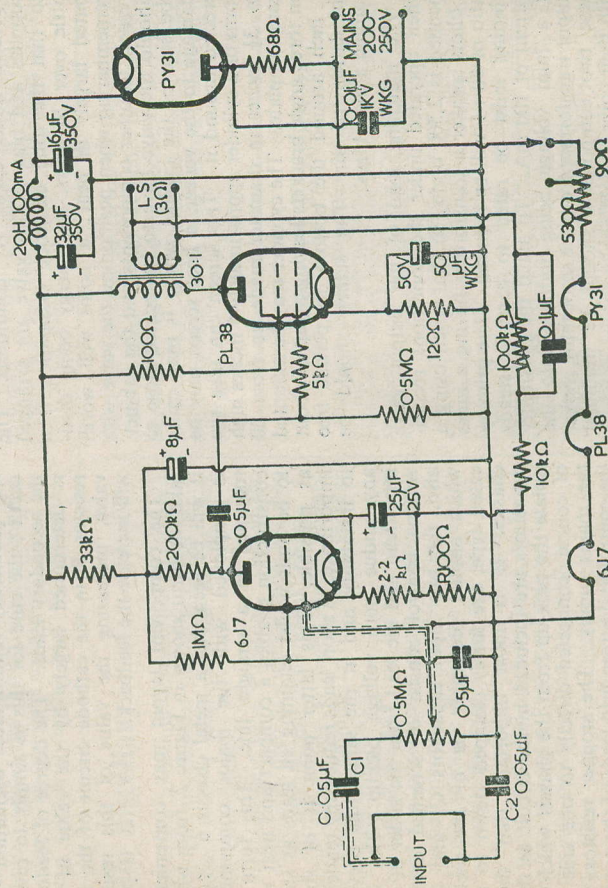

C.363

Fig. 1 : Circuit diagram of AC/DC 7 Watt Amplifier.

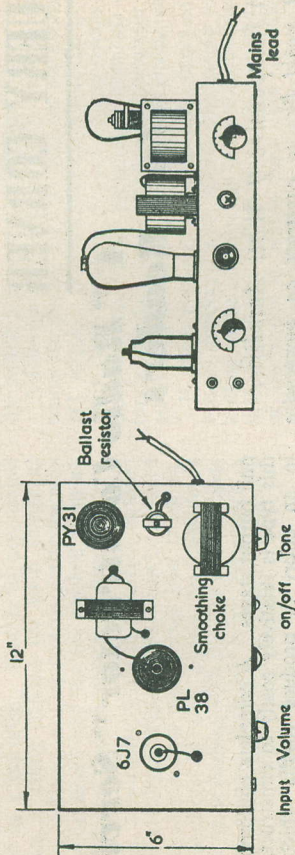

Fig. 2: Plan and side view of amplifier showing the general layout of components.

all voltage gain is sufficient to enable the output valve to be fully loaded when a high impedance magnetic or crystal type of pick-up is connected to the input socket; for microphone reproduction a further stage of amplification will, in general, be required.

The circuit consists of an RF pentode connected as a high gain voltage amplifier, which feeds into a 25 watt output pentode operated under class "A" conditions. The supplies and bias of this valve are arranged so that the total electrode dissipation is a little over 20 watts, this energy being dissipated largely in heat; a point well worth remembering when positioning the valve with respect to other components and the cabinet. Should the valve have to be located close to the side of the cabinet where it may cause damage to the veneer, a heat screen may be erected around it. This screen can take the form of a cylinder approximately 5 inches high on three angle brackets leaving a gap of about 1 inch around the bottom to permit free circulation of air. The screen should be painted a matt black.

The matching load of the output valve when operated under the conditions recommended is 2,500 ohms, so that when using a 3 ohms speaker a transformer having a turns ratio of 30:1 will be required. The primary winding must be rated to carry a steady current of 100 mA. To avoid the possibility of a hum voltage being induced into the output transformer from the smoothing choke, these two components should be mounted with their cores at right angles to one another.

A frequency selective negative feedback

circuit is used between the secondary of the output transformer and the cathode of the voltage amplifier valve. The adjustable resistance-capacitance combination in the feedback line controls the frequency response of the feedback loop, and hence also that of the complete amplifier. If the connections to the output transformer are not in the correct sense the amplifier will be unstable, and in all probability continuous oscillation will occur; the cure for this is simply to reverse the secondary leads. The degree of feedback is determined largely by the value of the resistor R in the cathode circuit of the first valve, increasing the value of this resistor will increase the feedback.

The component layout may conveniently take the form shown in Figure 2, from which it will be seen that a metal chassis 6" x 12" is employed with the major components mounted in a straight line. This form of construction enables a compact and neat unit to be built whilst retaining all leads as short as possible. This latter point is of some importance, as short leads reduce any tendency to instability and at the same time prevent any undue hum voltage pickup. The live input lead and the lead from the slider of the volume control consist of screened cable; also, the two input capacitors C1 and C2, which should preferably be of the metal-cased type, are firmly clamped down to the chassis. It is most important that these capacitors are included in the circuit as they isolate the pick-up from the chassis which is, of course, connected directly to one side of the mains supply. The stopper resistors in the control and screen grid leads of the output valve must be located as close to the valve socket as possible.

## QUERY CORNER

### "Rules"

- (1) A nominal fee of 2/- will be made for each query.
- (2) Queries on any subject relating to technical radio or electrical matters will be accepted, though it will not be possible to provide complete circuit diagrams for the more complex receivers, transmitters and the like.
- (3) Complete circuits of equipment may be submitted to us before construction is commenced. This will ensure that component values are correct and that the circuit is theoretically sound.
- (4) All queries will receive critical scrutiny and replies will be as comprehensive as possible.
- (5) Correspondence to be addressed to "Query Corner," Radio Constructor, 57, Maidin Vale, Paddington, London, W.9.
- (6) A selection of those queries with a more general interest will be reproduced in these pages each month.

pond to modulation frequencies between 1 Mcs and 3 Mcs, and by observing the effect of each trimming operation upon these bars it is immediately apparent whether or not the trimmer is being adjusted in the correct direction.

It will be found that as soon as the HF response of the amplifier is restored the picture will be reproduced with good resolution of the fine detail.

effect of its being subjective to the voice was quite marked. From the dance floor the first impression that the announcements were from a "live" M.C. actually in the hall, or at least quite distinct from the record, was quite startling.

## Electronics Exhibition

The sixth annual Electronics Exhibition organised by the North-Western Branch of the Institution of Electronics, will be held at the College of Technology, Manchester, on July 24th (from 2.30 p.m. to 9.10 p.m.) and on July 25th and 26th (from 10.0 a.m. to 9.0 p.m.).

An extensive programme is planned including, in addition to the products of the usual Exhibitors, a non-commercial section composed of exhibits from the Universities and from Scientific Associations.

There will be an exhibition of modern Scientific Films; demonstrations of the Compton Electronic Organ, of the Ferranti Logical Computer, and of Television Reception on home constructed receivers. Amateur Short-Wave Radio Transmitter/Receiver will operate throughout the period of the Exhibition.

Admission will be by tickets obtainable from Mr. W. Birwistle, Hon. Secretary, N. W. Branch, Institution of Electronics, 17, Blackwater St., Rochdale, Lancs. Catalogues will be available early in July.

Finally, because this amplifier is capable of providing an output power which is somewhat higher than that usually obtained from the two-valve type it is advisable to use a 10 inch speaker, which may, if it is so desired, be mounted in a separate cabinet. The use of a separate speaker cabinet can be advantageous in preventing vibrations from the speaker being transmitted to the gramophone pickup, thus forming a feedback arrangement which can ruin the quality of reproduction.

## TV Picture Lacks Detail

I have just completed the construction of a television receiver from a kit of parts and although a picture is obtained it is smudgy and lacks detail. What is the reason for this?

E. Rubens, Brentford.

When a television picture exhibits the characteristics outlined in this letter the trouble is due to a poor HF response in the vision channel. Assuming that the receiver has been correctly designed the cause is most likely due to misalignment of the tuned stages in the vision amplifier, in effect the response being such that the higher vision modulation frequencies are severely attenuated by the falling response. If a signal generator is not available the trimming procedure must be one of trial and error methods, and it is best attempted whilst the B.B.C. are transmitting the pattern known as Test Card "C". This pattern contains vertical bars which corres-

## Radio Miscellany

Contd. From P. 431

a modulator in rack and panel form, I changed the output transformer of the amplifier when I loaned it to a local club for use at their weekly club dances.

Three speakers were wired in. Two in the hall which was used as a dance floor, and one in a recreation-cum-refreshment room. A separate fader was arranged on a control panel beside the amplifier to control the speaker in the refreshment room.

The son of the M.C. on his own initiative brought the refreshment room speaker back into the hall, positioning it at the far end. He had learned a couple of old-time dance records off by heart—the type where the M.C. calls instructions about the dance formations. At each point where the voice broke in, he faded down the two main loud-speakers and turned up the gain on the one at the far end.

The effect was momentarily uncanny—the voice coming from a different direction seemed quite independent of the record. The music level, of course, was about the same but the



## Radio Miscellany

It looks as if I shall soon be celebrating the completion of the fifteenth year since I first adopted the sobriquet Centre Tap. If anyone had then forecast so long a run I should probably have been the last to believe him! In fact, if it had not been for G5GQ (the Editor responsible for its first appearance) it would have only run for two or three issues.

The idea was for a commentary on points of general interest under a vague, and therefore comprehensive, title: to be written to the readers, not at them.

I felt he could make a better job of it himself than I could, but he insisted he was too tied up with other things. Incidentally, now he is able to give more time to the hobby, G6CL (over a few pints) might induce him to do something of that sort for the Bulletin. (No charge for the tip!)

G5GQ said it was good, and argued it would get still better. Then when readers began to confirm his view I found myself committed to it.

If, since then, I have succeeded in satisfying a goodly percentage of readers I must be grateful to the two extremes, the expert and the beginner, for their leniency. Few things can be more irritating than to be solemnly told things you already know, while for the beginner it is equally galling to be expected to know of things that he hasn't already heard about.

When it occurred to me that I had to satisfy all those in the middle, and not let those at either extreme feel they were being cheated out of anything, I decided I was being let in for an awful lot of responsibility. Happily, the recipe soon came to me. If you try to please everybody, you will never succeed in satisfying anyone. Just please yourself and you are at least sure of one satisfied reader. Oddly enough it worked out. As a commentator (who ought to know most things) I should be able to explain why, but it's beyond me!

### The Music goes Round—and Round

Thinking of old receivers, and hearing some of them in operation, is perhaps the perfect example of how the human animal can readily deceive himself that reproduction is satisfactory—often in face of the musically-sensitive stranger's horror at finding it so perishin' awful.

While the best reproduction is only an approximation of reality, that is no good reason why people should actually learn to enjoy their own particular form of distortion.

But they grow by habit to regard it as natural. We can none of us be sure we have the gift "to see ourselves as others see us", and I often wonder if, with inevitable gradual deterioration, my own quality receiver has marked faults to which I have grown so accustomed that I can no longer detect them myself.

The opinion of musically minded friends can be invited, of course. There is then the danger that they, having drugged themselves by continual listening to some minor imperfections of their own receivers might, by comparison, find imagined imperfections in yours.

The only safe way seems to be to hear the real thing as often as you can, and then keep your fingers crossed until FM really arrives.

### Veterans

Many hundreds of new radio receivers are sold each day. What happens to all the old ones?

Perhaps, like old soldiers, they simply fade away. Dealers will often tell you that the majority they take in part exchange are no longer fit for service, unless an uneconomic amount of time and material is spent on them. The ones they get are often fit only for the scrap heap.

Between the Wars, wily listeners used to tour round certain types of dealer enquiring part exchange values. So much so, that it in fact became a form of price cutting.

Old radios, if they can be cheaply made serviceable, have a comparatively high value nowadays, thanks to purchase tax and increasing production costs. Many readers will remember the days when you could buy a midget Universal of American make for £3 or less. Secondhand receivers naturally had but little value then. Now the cheapest receivers are around £11 upwards; secondhand values have shot up in proportion.

Most purchasers of new receivers seem to prefer to keep their old one as a stand-by, or for use in the bedroom, kitchen or even the garage. Some get passed on to less fortunate relatives. If the set is very old the customer often decides to scrap it himself and use the speaker as an extension. Partially, maybe, because he has grown to love the particular form of distortion to which the old one was prone!

Also, the wood from the cabinet has a great scarcity value nowadays for all sorts of jobs, and in any case everybody has a natural

urge to put a piece of polished wood away because it will come in for something useful one day. Often it doesn't, of course. Pieces of wood have a disconcerting habit of always being just a half-inch short of the length you want. Thus the customer prefers to keep his old receiver rather than accept a purely nominal price for it.

If the trend continues we may yet see a return of the offer of "highest price allowed for your old set", especially in view of the sales resistance built up by the increase in purchase tax.

### Reflection

The accident resulting in the electrocution of a home-constructor in Gloucestershire is a grim reminder of the danger of experimenting with TV unless one has taken every precaution—and then made a double check.

It is a wise policy, whenever possible, to have someone around who knows how to switch off and what to do in case of mishap when adjustments have to be made to live gear employing high voltages. This is particularly important when tests have to be made under working conditions.

It is as well to remember, too, that high voltages in TV receivers are not confined to the EHT supply only. The anode of the line-scan output valve may have pulses of up to 1,000 volts, and the frame scan output valve can possibly have 500 volts on its anode. While these circuits are of high impedance and cannot deliver a high enough current to normally prove lethal, accidental contact with them is, to say the least, unpleasant.

deliberately shorted. It may, especially with high voltages, ruin the component.

Happily, modern design employs EHT from the line flyback, when these dangers are obviated—at least, their deadliness. Even so, it must be treated with the greatest respect. Whenever making adjustments to a TV set when it is working, stand a mirror in front of the screen. You can then watch the effect of the adjustments in the mirror and keep an eye on what you are doing at the same time.

### Futurist

Some readers may have been to the "cinema-of-the-future" at the Festival of Britain Exhibition, and formed their own ideas about the stereoscopic picture and ventriloquial sound effects. The three dimensional picture is certainly vivid, especially when accompanied by "three-dimensional" sound.

For the stereoscopic vision, obtained by two overlapping pictures, special spectacles have to be worn. The idea is quite old. Stereoscopic film projection on the same principle was used well before the first World War, but it still suffers from the limitation of special spectacle wearing. Once the novelty has worn off the strain is quite noticeable.

The accompanying sound—dubbed "stereophonic"—is still more effective. It is also a greater technical feat. The sound comes in turn from 24 loud speakers hidden behind the screen, at the sides of the proscenium, in the roof etc.

In this way, the sound can follow the players as they move across the screen to add to the realism.

## CENTRE TAP talks about OLD CROCKS - HIGH VOLTAGE - STEREOPHONY

Such a shock may, too, cause one to do damage to the receiver or, worse still, make contact with the EHT.

EHT taken from the mains through a rectifier and transformer is the most dangerous. Even if the supply has a bleeder resistance fitted, watch your step. Resistances have been known to go open circuit.

A 100,000 ohm resistor mounted on a long insulated handle, held across the terminals of each high-voltage capacitor for ten seconds or so after switching off, is the minimum precaution one should take. Then as an additional safeguard, short circuit each with the blade of a screwdriver.

A charged capacitor should never be

Frankly, I do not think stereoscopic pictures in this form will have any marked influence on the cinema, but stereophonic sound has far more promise once the difficulties have been ironed out. It is no easy task to automatically select which of a bank of speakers is to take a given passage of sound, and then to change it as the source of the sound moves across the screen.

"Take Your Corners . . ."

Stereoscopic sound is, of course, no novelty. The drawback is that it needs manual operation. Strangely enough, its first effective use in my experience was some years ago by a school-boy—with my amplifier. Originally built as

Contd. from P. 429

## A Useful . . .

# HEATER TRANSFORMER

By W. E. THOMPSON

THE recently published series of articles entitled "Building your own Valve Tester" by our popular contributor W. G. Morley set some wheels working in the mind of the present writer, for the utility of the instrument appealed to him. In the course of adapting some pet circuit principles to the published design, the question arose of providing a suitable heater transformer. Reference to Mr. Morley's article, page 20, August issue, will reveal that the transformer has to supply a wide range of secondary voltages, and it is fairly certain, as he points out, that such a component is not generally available and would most likely have to be purchased on special order.

Now I am not one of those people who could afford to have such a transformer specially made, even if I wanted to. It is true to say that being able (fortunately) to design my own windings has saved me more hard cash than I care to think about, for over the past twenty years all my transformers and chokes have been designed and made in the "den". Consequently, it was natural that I should set about designing a heater transformer for the Valve Tester, though it must be admitted that the final design did not fully conform to Mr. Morley's specification. This article gives details of the construction of the transformer made by the writer, the secondary windings

design being that which he decided best suited his own requirements. It is offered as a useful alternative, and it is thought that its ease of construction will meet with some approval. The most outstanding feature is, perhaps, the fact that the stallo stampings necessary can be obtained from a popular ex-Govt. unit.

It is usual in transformer design to base the design on continuous rating and allow a temperature rise of about  $50^{\circ}\text{C}$  and maximum operating temperature of  $95^{\circ}\text{C}$ , this in turn fixing the current rating of the windings to a maximum of 2000 Amps. per square inch cross section of the conductor. In this design, however, these limits have been extended, and permissibly so, for when testing a valve the actual time taken to do so is very small, and the transformer barely has time to start heating up. If we agree this latitude, we can safely increase slightly the current rating of the conductors in order to obtain a smaller transformer, using as small a wire gauge as possible. These considerations are mentioned just in case it should be thought that the wire sizes appear inadequately small.

In my case, I did not need to have available the full range of voltages given in column (2) of the table. The range was therefore restricted so that the secondary gives 1.4, 2, 2.6, 3.3, 4, 5, 6.3, 7.5, 10, 13, 15, 20, 24, 30, 33, 42 and 50 volts, the current ratings being fixed at 3 Amps

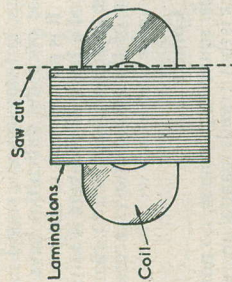

FIG. 1. REMOVING COIL

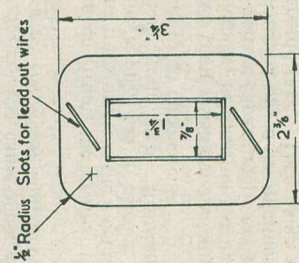

FIG. 2. BOBBIN  $\frac{1}{8}$ " PAXOLIN

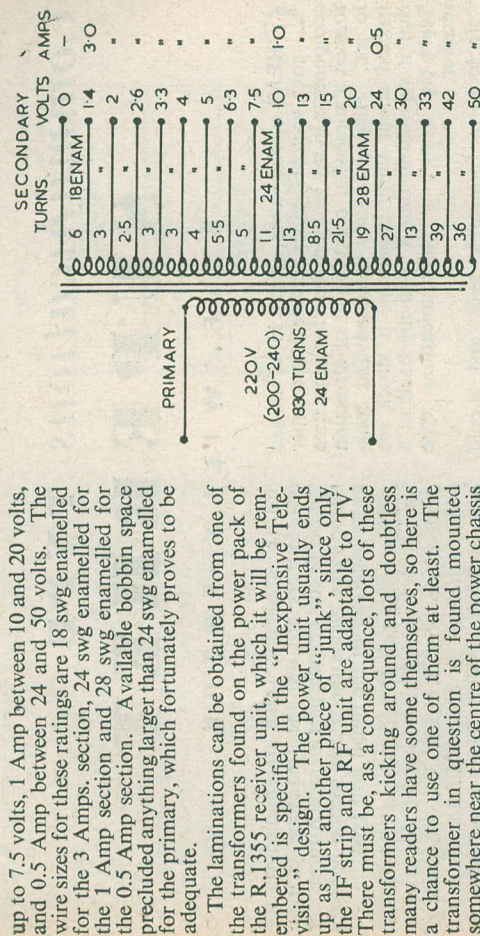

FIG. 3

WINDING DIAGRAM

C221

up to 7.5 volts, 1 Amp between 10 and 20 volts, and 0.5 Amp between 24 and 50 volts. The wire sizes for these ratings are 18 swg enamelled for the 3 Amps. section, 24 swg enamelled for the 1 Amp section and 28 swg enamelled for the 0.5 Amp section. Available bobbin space precluded anything larger than 24 swg enamelled for the primary, which fortunately proves to be adequate.

The laminations can be obtained from one of the transformers found on the power pack of the R.1355 receiver unit, which it will be remembered is specified in the "Inexpensive Television" design. The power unit usually ends up as just another piece of "junk", since only the IF strip and RF unit are adaptable to TV. There must be, as a consequence, lots of these transformers kicking around and doubtless many readers have some themselves, so here is a chance to use one of them at least. The transformer in question is found mounted somewhere near the centre of the power chassis and it carries, among others, a green vitreous resistor. (The transformer NOT required for this design is the smaller of the two, and has a pre-set variable resistor mounted on the paxolin sub-panel). Remove the transformer from the chassis and strip it of all wiring and resistors. Dismantle tag panel and core clamps, then saw through winding as shown in Fig. 1. The part of the coil then remaining in the core can now be gently pressed out, leaving the core only. The stampings should be carefully separated with a pen-knife.

Make up a bobbin from  $1/16$  inch thick paxolin to the dimensions given in Fig. 2. The rectangular holes in the cheeks are best cut on a fretsaw machine, but in the absence of this one must resort to drilling several small holes in the waste piece in order to knock it out, and then finish the hole to size with a file. All pieces must be true to size, and square, in order to obtain a strong bobbin. Assemble the pieces to form the bobbin and paint the joints of cheeks and centre tunnel with thick nail varnish, leaving at least twelve hours to harden. The sharp edges of the bobbin centre should be rounded with a file. Slots in the cheeks for leading out ends of windings should, of course, be cut before the bobbin is assembled.

A suitable winding spindle presumably being at hand we are now ready to wind the coils. Wind the primary with 24 swg enamelled wire in close-wound layers, and as each layer is wound put on a single turn of very thin paper before winding the next layer of wire. Continue thus until 830 turns have been wound. This winding has a nominal rating of 220 volts, and will not introduce much error in rated secondary voltages if used on mains voltages ranging from 200 to 240 volts.

Put at least two, and preferably three, layers of 5-mil empire tape over the primary. For the first section of secondary, wind 32 turns of 18 swg enamelled wire, bringing out tappings at 6, 9,  $11\frac{1}{2}$ , 14,  $17\frac{1}{2}$ , 21, and 27 turns. This will take two layers, and one layer of empire tape should be put on top of each layer. For the second section, wind 54 turns 24 swg enamelled wire, bringing out tappings at 11, 24 and  $32\frac{1}{2}$  turns. With care it may be possible to get this all in one layer. Then, one layer of empire tape before putting on the third and last secondary section, which should be 134 turns 28 swg enamelled with tappings at 19, 46, 59 and 98 turns. This last section can be slightly "spread" to occupy two layers, one layer empire tape being put on between layers and the coil finished off with two layers of tape for protection and appearance. The empire tape between secondary layers is more for forming a sound base for the next layer of wire than for high insulation purposes.

Some care in winding is necessary since the bobbin just takes the amount of wire with comfort. For reference, Fig. 3 is a diagram of the windings showing the number of turns between tappings and the voltages at the tappings.

When removing the wound bobbin from the winder, take care, for it is at this critical stage that end cheeks have a nasty habit of flying off! To drop the coil invariably spells disaster, as

Contd. on P. 442

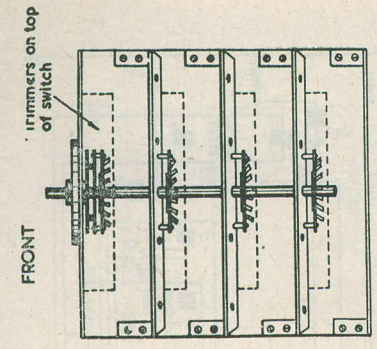

FIG. 2. COIL BOX SEEN FROM ABOVE

in circuit without danger to its delicate construction—it is a 0.1 mA moving coil type.

Now, the IF amplifier section with its imposing array of eight tuned circuits looks somewhat unusual because, after the first normal IF transformer, two transformers in tandem couple the fourth valve to the second IFT, with the coupling between the secondary of the first tandem transformer and the primary of the second one obtained by means of a 5-20 pF microvariable capacitor. This bandpass coupling capacitor is adjusted until splash-over interference is most attenuated, with the speech remaining still intelligible. Then it is best left alone, as any variation may affect the peaking of the IFT to a certain extent. On the other hand, if a precision slow-motion dial is fitted, such as the Admiralty Pattern 1257, the capacitor can always be readjusted to the original setting. Very slight alterations to the setting sometimes makes a remarkable difference to the reception of short wave stations. The intermediate frequency is 465 kcs.

The remainder of the line-up and layout is conventional, except perhaps for the coupling of the output valve, which is fed from the triode section of V6 via a parallel-fed AF transformer, ratio 1 : 4, with a simple kind of negative feedback (R54).

The power supply, which is not shown in this circuit, consists of a conventional full-wave rectifier (5Z4) which feeds a very efficient smoothing arrangement. The AC consumption is about 60 watts.

A receiver such as this is bound to need quite a lot of coils, and we have: 6 Aerial coils, 6 RF coils (1st RF stage), 6 RF coils (2nd RF stage), 6 Oscillator coils—a total of 24 coils in the tuning unit, plus 24 trimmers (15-50 pF), 4 IF transformers, and 3 RF chokes (Denco RFC7B).

As indicated, the writer had a lot of coils in his junk box, a very odd mixture of different makes which eventually resulted in the following arrangement: Range 1, Denco Maxi-Q chassis coils (Denco range 5) iron cored; Range 2, Bel Sound Products coils, iron cored; Range 3, Wearrite 'P' coils, air cored; Range 4, Weymouth 'H' coils, iron cored; Range 5, Bel Sound Products coils, iron cored; Range 6, Wearrite 'P' coils.

These coils were used in the first experimental job. The performance of the set did not suffer from the difference of the coils, but with some of them fixed on top, others fixed at the base, some with and some without iron cores, it took a lot of thinking to arrange a suitable layout, and consequently the set of 24 coils took up too much space and definitely made some connections far too long. For the final set—if a constructor's set is

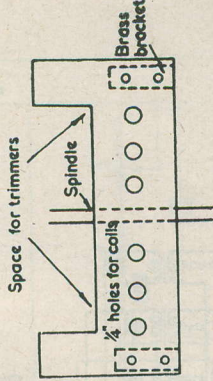

FIG. 3.

ever final!—I therefore used coils of one make throughout, Supacoils, and these for the one and only reason that they are cheap and very good indeed.

The transformers, however, are still a mixed lot. The fourth IFT is centre-tapped on both primary and secondary windings (the only one of this kind which I could find was at Messrs. Alec Davis); the third one is an old Hammarlund air cored transformer, the coils of which are variable to permit the resonance curve to be adjusted so that local stations may be received at best quality. The other transformers are ex-WD surplus.

Bandspread is provided for by four coupled 3-18 pF microvariable capacitors. These are type 10C2070, which were the only ones I could find with a spindle length of 1/2" at both ends. The four-gang variable capacitor was a 5s. bargain and a peach at that, but the overall length is only 4 1/2", with 1" for each section. The set of 24 coils, each section screened

# Communications TYPE SUPERHET

BY F. WILLY FRERK

are RF amplifiers, which are coupled via RF transformers to V3, the frequency changer (6K8GT) the hexode part of which forms the mixer valve, while the triode section operates as an oscillator of the tuned grid type.

Then come two IF amplifiers (VR53/EF39) V4 and V5, which are followed by double-diode-triode V6 (VR55/EBC33), one diode of which functions as a demodulator, with the other providing AVC. There is no delay on the latter, in order that good indications of weak signals may be obtained on the 'S' meter. The triode section acts as first AF amplifier, and is followed by the output pentode (6V6). V7 (6H6) is a noise limiter of the series type, which may be switched in or out by a switch on the panel. A beat frequency oscillator for CW reception (preferably the compact Denco combination) may be connected at the points marked o-o. A crystal filter may also be added at X-X, but this calls for some changes after the first IF transformer.

The RF gain control operates on the first RF stage only, and the IF gain control on the first IF stage only. It is, of course, possible to combine both controls, or to control both RF stages and both IF stages separately, but I prefer the present method. The AF control is the normal 500 kΩ grid leak of the triode section of V6, operating in the usual way as a gain control.

The diode of V7 in series with the 'S' meter prevents reverse current upsetting the movement; the meter may be switched off or left

CHEAP surplus valves, quite a lot of unused coils, switches, potentiometers and other components in my junk box had for some time formed a somewhat bulky point of attraction to me. Having already designed and constructed about thirty superhets, it struck me that it was about time I tried my hand at a 'real big thing', a communications type receiver.

It looks a formidable task, and should definitely not be tackled by the inexperienced constructor. Although the final construction is not so difficult, the layout, choice of components and accurate alignment are, however, a rather tricky business.

In this article a study of the circuit and a few hints may suffice, but if readers are interested in this design the writer is prepared to give a more extensive account of it. The line-up is eight valves plus rectifier, employing ex-Govt. type valves throughout. Six wave ranges are covered, tuning from 31.5 Mcs (9.5 metres) to 150 kcs (2,000 metres), by means of a double pole, six way, four bank switch. Short wave fans, who may not be interested in medium and long waves, could use plug-in coils, which would enormously simplify the construction and enable shorter leads to be used. Plug-in coils are, however, somewhat cumbersome when wave-changing has to be done in a hurry. The set is designed to work off AC mains only (200-250V).

The eight valves perform the following functions:— V1 and V2 (each a VR53/EF39)

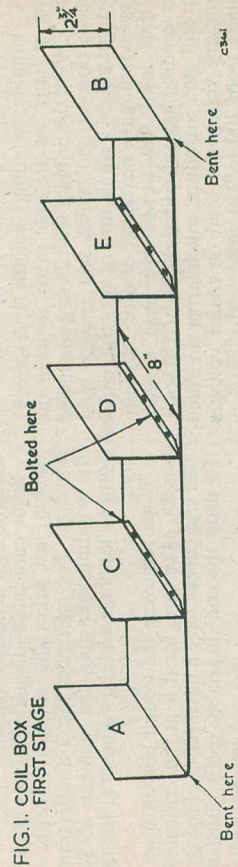
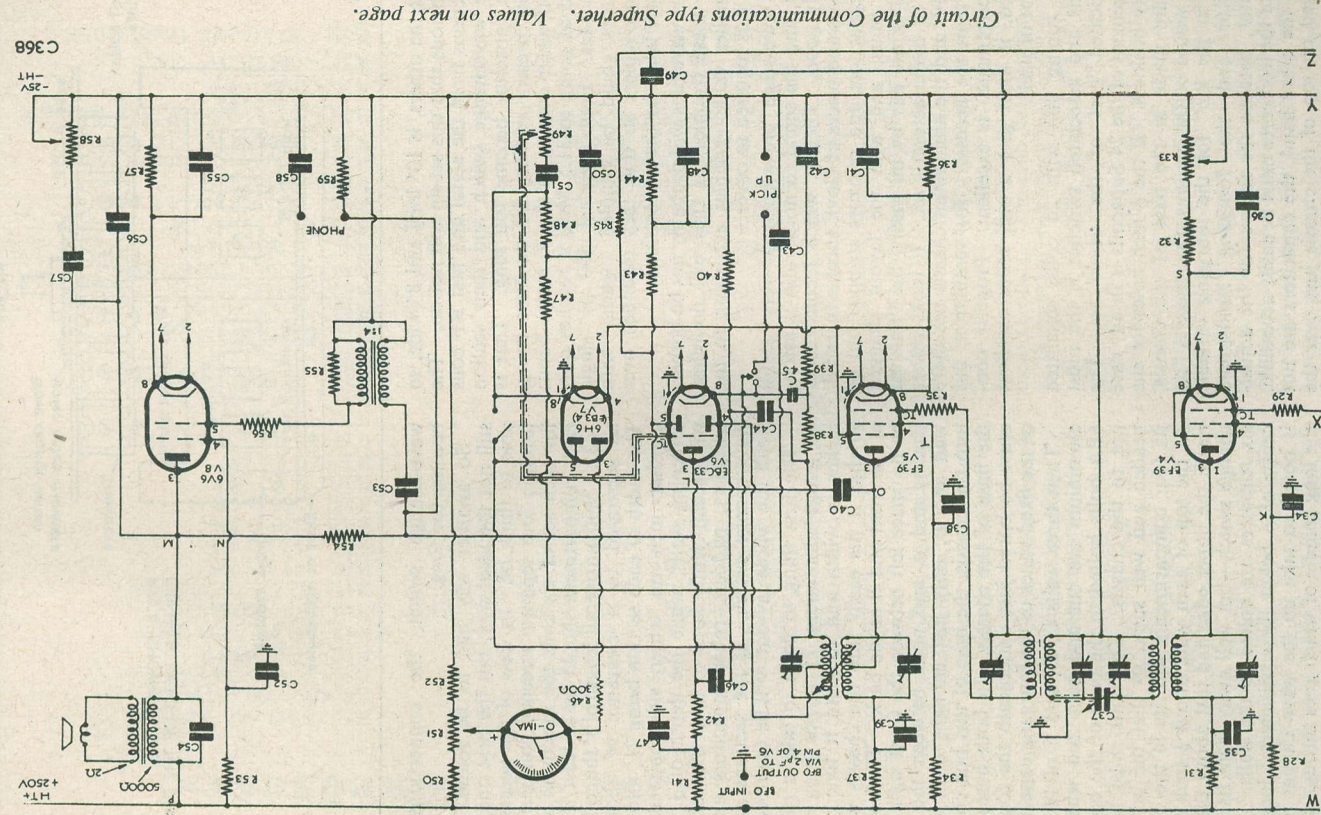
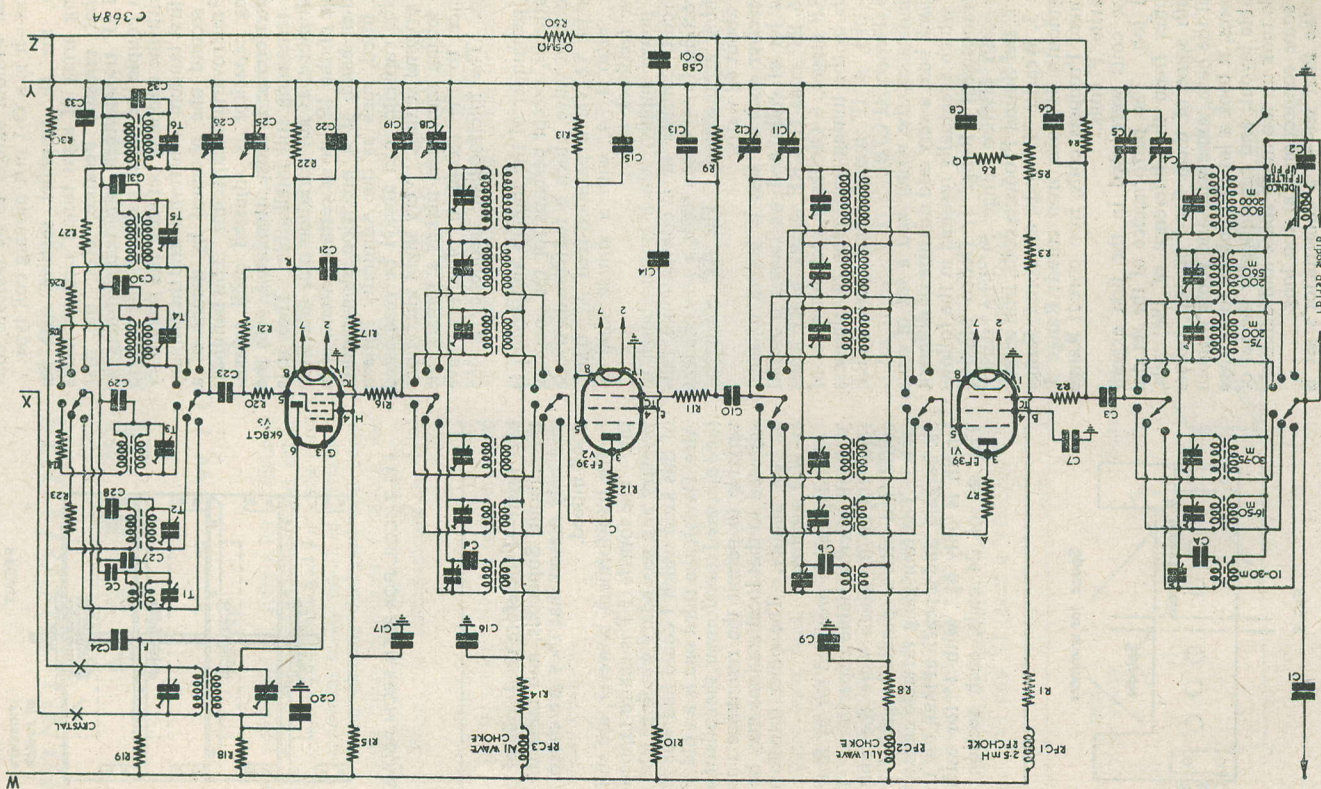

FIG. 1. COIL BOX FIRST STAGE

CS-4



Circuit of the Communications type Superhet. Values on next page.

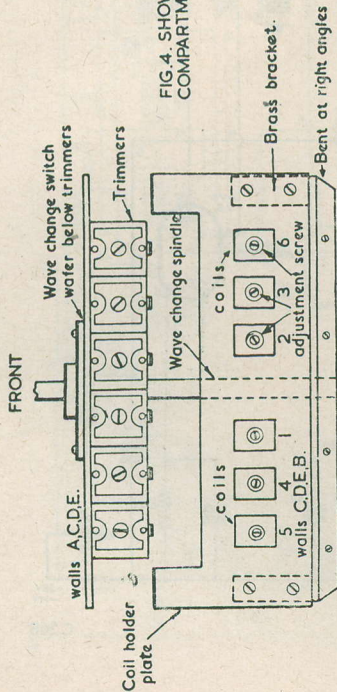

FIG. 4. SHOWING ONE COMPARTMENT OF THE BOX.

against the others, is 10" long and 8" wide, so it is obvious that this set-up will not do. The connections from the aerial and first RF coils to the wavechange switch and their section of the capacitor become too long. That is why my present version, for the time being, falls off when coming to the 10 metre band; instead of going to 31.5 Mcs, it reaches only to 25 Mcs. Four identical 500 pF single capacitors could be coupled together with flexible couplers so that they extended over the space taken by the coil sections.

Short wave fans will probably not be bothered by these troubles, as they will doubtless use smaller value variables according to the bands it is required to cover.

The two-stage pre-selector is very useful indeed, and the signal to noise ratio is astonishingly good. The rig, which I constructed from bits and pieces of Govt. surplus material, with capacitors and resistors stripped out of funny units, and with the layout changed several times, has by no means the "finished look" of manufacturer's set. It looks rather hazy, and the aluminum chassis has more holes than are necessary for ventilation, but the performance is excellent. Properly constructed, it must give a still more excellent account of itself.

The tuning unit, with 24 coils, separated sections and associated switches is the most complicated part of the whole set. The arrangement of the 24 Supacoils is in any case a tricky business. If the 1/2 inch holes for the coils are made in the base of the chassis, which would be the obvious way, there is "no room in the inn" for the fourgang variable capacitor and the fourgang bandsread capacitor, because the screws for the adjustment of the iron cores must be easily accessible. If, on the other hand, the capacitors are not mounted on top of the chassis just over the

wave-change switch, the connections will become too long.

So another way had to be found. It is still not the ideal way, but the best one I was able to think of. In view of the necessity of forming four separate screened compartments for each set of six coils the minimum size of each compartment should be at least 8 x 2 1/2 x 3". With an overall length of 8" the coils may be separated by a clearance of about 1". The width of each section being 2 1/4" allows for another inch on either side opposite the screening walls, while the depth of 3 inches will be sufficiently large to take the coils, the trimmers, paddlers, other capacitors and the wave-change switch. If the sections are too small the whole lay-out will be cramped.

The first thing to do is to take a piece of 16 gauge aluminum 25 inches long and 8 inches in width and to bend it like Fig. 1, so that it fits easily into the chassis with A at the front and B at the back. There should be no space left between the front wall of the chassis and A and none between the back-wall and B, only just enough to fit snugly into the chassis, the base of this box covering the base of the chassis. In both bases holes must be bored just underneath the four tags of the fixed vanes of the fourgang capacitor.

Then three walls C, D, and E of 16 gauge aluminum are cut and bent and with four 6BA bolts bolted to the base of the box, but not to the chassis. The bolts must be flat-headed and well sunk, so that the box with its four compartments still fits in the chassis. At the top of each wall, about 1/2 inch underneath the upper edge and just above the wave-change switch—but well away from its tags—six trimmers are bolted to the walls. In the centre of A below these trimmers a large hole is bored to take up the wave change switch, the long spindle of which goes through smaller

LIST OF COMPONENTS

- R5, 5 kΩ pot. RF gain
- R6, 46, 300 Ω 1/2 W
- R8, 14, 4.7 kΩ 1 W
- R10, 100 kΩ 1 W
- R13, 25, 52, 400 Ω 1/2 W
- R16, 23, 100 Ω 1/2 W
- R18, 31, 37, 4.7 kΩ 1/2 W
- R19, 47 kΩ 1 W
- R21, 47 kΩ 1/2 W
- R22, 250 Ω 1/2 W
- R24, 200 Ω 1/2 W
- R26, 1 kΩ 1/2 W
- R27, 2 kΩ 1/2 W
- R28, 34, 38, 100 kΩ 1/2 W
- R29, 35, 50 Ω 1/2 W
- R32, 500 Ω 1/2 W
- R33, 10 kΩ pot. IF gain
- R36, 330 Ω 1/2 W
- R39, 60, 500 kΩ 1/2 W
- R40, 5 kΩ 1 W
- R42, 250 kΩ 1 W
- R43, 44, 59, 250 kΩ 1/2 W
- R47, 1 MegΩ 1/2 W
- R48, 2.2 MegΩ 1/2 W
- R49, 500 kΩ pot. AF gain
- R50, 50 kΩ 2 W
- R51, 1 kΩ pot. S meter control
- R53, 300 Ω 1 W
- R54, 2.5 MegΩ 1/2 W, neg. feedback
- R56, 10 kΩ 1/2 W
- R57, 240 Ω 1 W
- R58, 50 kΩ pot. Tone control

- C1, 5 pF
- C2, 150 pF
- C3, 23, 24, 100 pF var.
- C4, 11, 18, 25, 500 pF var.
- C5, 3.18 pF var.
- C6, 12, 13, 33, 48, 49, 51, 54, 57, 58, 0.01 pF
- C7, 8, 9, 14, 15, 16, 17, 20, 21, 22, 34, 35, 36, 0.00455 pF
- C8, 0.0037 pF
- C9, 0.001 pF
- C10, 0.001 pF
- C11, 0.001 pF
- C12, 0.001 pF
- C13, 0.001 pF
- C14, 0.001 pF
- C15, 0.001 pF
- C16, 0.001 pF
- C17, 0.001 pF
- C18, 0.001 pF
- C19, 0.001 pF
- C20, 0.001 pF
- C21, 0.001 pF
- C22, 0.001 pF
- C23, 0.001 pF
- C24, 0.001 pF
- C25, 0.001 pF
- C26, 0.001 pF
- C27, 0.001 pF
- C28, 0.001 pF
- C29, 0.001 pF
- C30, 0.001 pF
- C31, 0.001 pF
- C32, 0.001 pF
- C33, 0.001 pF
- C34, 0.001 pF
- C35, 0.001 pF
- C36, 0.001 pF
- C37, 0.001 pF
- C38, 0.001 pF
- C39, 0.001 pF
- C40, 0.001 pF
- C41, 0.001 pF
- C42, 0.001 pF
- C43, 0.001 pF
- C44, 0.001 pF
- C45, 0.001 pF
- C46, 0.001 pF
- C47, 0.001 pF
- C48, 0.001 pF
- C49, 0.001 pF
- C50, 0.001 pF
- C51, 0.001 pF
- C52, 0.001 pF
- C53, 0.001 pF
- C54, 0.001 pF
- C55, 0.001 pF
- C56, 0.001 pF
- C57, 0.001 pF
- C58, 0.001 pF
- C59, 0.001 pF
- C60, 0.001 pF
- C61, 0.001 pF
- C62, 0.001 pF
- C63, 0.001 pF
- C64, 0.001 pF
- C65, 0.001 pF
- C66, 0.001 pF
- C67, 0.001 pF
- C68, 0.001 pF
- C69, 0.001 pF
- C70, 0.001 pF
- C71, 0.001 pF
- C72, 0.001 pF
- C73, 0.001 pF
- C74, 0.001 pF
- C75, 0.001 pF
- C76, 0.001 pF
- C77, 0.001 pF
- C78, 0.001 pF
- C79, 0.001 pF
- C80, 0.001 pF
- C81, 0.001 pF
- C82, 0.001 pF
- C83, 0.001 pF
- C84, 0.001 pF
- C85, 0.001 pF
- C86, 0.001 pF
- C87, 0.001 pF
- C88, 0.001 pF
- C89, 0.001 pF
- C90, 0.001 pF
- C91, 0.001 pF
- C92, 0.001 pF
- C93, 0.001 pF
- C94, 0.001 pF
- C95, 0.001 pF
- C96, 0.001 pF
- C97, 0.001 pF
- C98, 0.001 pF
- C99, 0.001 pF
- C100, 0.001 pF

holes in C, D and E.

The box has now an aluminium base and four equally sized compartments, but is open on top, showing the trimmers and the wave change switch, and is open to both sides. On each end of C, D and E about 1/2 inch underneath the upper edge small brass brackets are bolted, to take the coil-holder plate, the construction of which is the next task. (Fig. 2)

Four strips of aluminium 8" long and about 3" wide are cut and put on the brass brackets. They will not fit, because the trimmers are in the way. The strips are, therefore, cut and filed the way Fig. 3 shows, and holes bored corresponding to the holes in the strips. Along the centre of the remaining strip six equally spaced 1/2 inch holes are bored to take the coils. The coils must be mounted in groups of three, three coils to the left and three coils to the right of the wave change switch, to

leave room for the spindle which has an overall length of 10 to 12 inches and runs from the front of the set to the back. Now the coils can be secured in their holes by means of their Spire speed nuts. It is, however, a good idea to put a drop of Durofix on each coil to keep them in place. The coil plate is then bolted to the bracket and the whole coil box looks from above like Fig. 4 and from below like Fig. 5 (it is presumed the base has been removed).

When all fits nicely, when all trimmers and adjustment-screws of the iron cores are easily accessible and the wave change switch works satisfactorily, we can start with the wiring. And that is the trouble with this construction, that one has to wire one section after the other and that, if a mistake is made, the whole work has to start again from the beginning.

Thus, the wiring has to be done with all

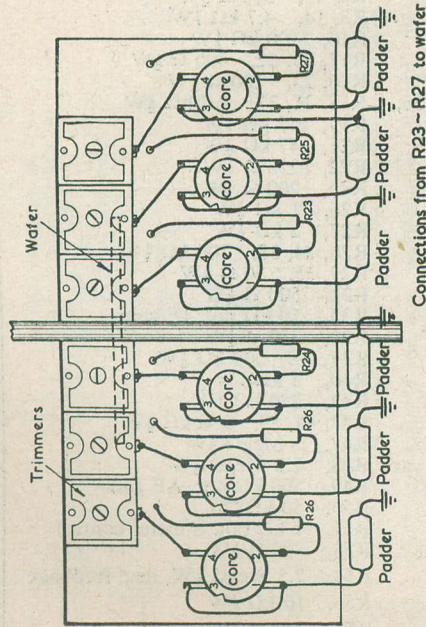

FIG. 5. COIL BOX SEEN FROM BELOW (BASE REMOVED)

CS48

possible are and attention, using stout tinned copper wire well covered with sleeving. It is a good plan to solder a sufficient length of wire to certain tags of the coils before fixing them to the coil plate, but not to all tags, as will be shown later.

When Wearitie P-coils are used the set-up is much less complicated in that they are air-cored and a special coil-plate is not necessary. These coils can be fitted directly with trimmers of the postage stamp kind and can be secured below the ganged capacitor directly to the base of the chassis by a 6BA bolt passed through the chassis from above. In my experience, air-cored coils have proved to be as efficient as iron cored ones, though it cannot be denied

that the latter may exhibit greater selectivity. Iron cored coils adapt themselves easier to accurate and quick matching, but often induce the home constructor to try a further improvement, which usually fails with the result that they do not match any more.

The smallest iron-cored coils which can be mounted like the P-coils are the Weymouth coils, which might be the solution of the complicated tuning-unit, but with a mournful weather-eye on my pocket-book I had to abstain.

It is obvious that for trimming and padding operations the chassis must be inverted, but that does not mean any inconvenience to the keen constructor.

Before one starts with the wiring, the first wafer of the wave change switch must be secured on the spindle and fixed with adequate spacers near the wall A. Make sure that the contacts to the rotor nearest to the hole in the base, leading to the first section of the capacitor are on top of the box and very near the trimmers. Solder a stout piece of wire to the rotor and wires of sufficient lengths to the contacts and fix the wafer. Starting with the contact farthest to the left draw that wire through the tag-hole of the trimmer farthest to the left, cut and fix it to that hole, but do not solder it. The wire of the next contact goes through the hole of the next trimmer and so on until all contacts of the wafer are connected to their respective trimmers.

Tag 4 of each coil, Fig. 6, has to be connected

to the grid of the valve, that is to the trimmer. When the wire is mechanically fixed to the trimmer, where the wire from the switch-contact has already been fixed, both together are soldered to the trimmer. Tag 3 has to be dealt with in a different manner according to the compartment the coil is in. In the oscillator compartment tag 3 is usually connected to earth, because it is the earthy end of the oscillator anode winding. In our set, however, we connect tag 3 with the unearthened side of the padder capacitor, that is direct to tag 1, except in the case of the long wave coil which should be connected direct to chassis. Tag 2 is connected to the contact of the wave change switch going to the anode of the valve. In our case between tag 2 and the respective contact of the wafer are the small resistors R 23 to R 27 which maintain a constant value of heterodyne voltage. Tag 1 of the oscillator coil is connected to the padder capacitor, which should be soldered with the shortest possible length of wire to the tag, while the other end is soldered to a tag fixed on the chassis.

Now, wall C is fixed to the base of the box and the whole work starts again with the second compartment, but with some difference Tag 4 goes to the grid as before; tag 3, however, of all the coils of this compartment are connected together. The wires must be carefully sleeved, and they end on the right-hand side of the box in an insulated tag-strip fixed to the wall. On the left-hand side of the compartment an 0.1  $\mu$ F capacitor is soldered to this line ending in tag 3 of the medium-wave coil. The other end of the capacitor goes to the chassis. Tag 2 goes to the anode-contact of the switch and tag 1 to the chassis.

After fixing wall D we repeat exactly the same procedure in the third compartment. The fourth compartment, containing the aerial coils, is easier to wire, but it has to be done with the same care. Tag 4 to trimmer and grid, tag 2 to those contacts of the wafer which were the anode-contacts in the other compartments, and tag 1 to earth.

The two rotor of each wafer differ in their connections like this:

Oscillator:

Rotor for the upper contacts (bushed with rubber grommets) to the first section of the four-gang capacitor. Rotor for the lower contacts to a tag-strip on the right-hand side of the compartment and later from there to the oscillator anode.

First RF

compartment: Rotor for the upper contacts: same as before, but to second section of capacitor.

Rotor of the lower contacts to

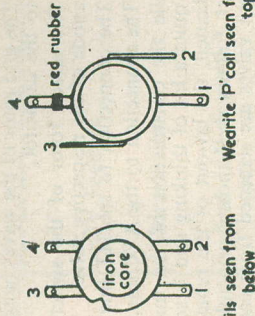

FIG. 6.

CS46

tag-strip and from there to the anode of the second valve. compartment: Rotor for upper contacts: same as before, but to third section of capacitor.

Rotor for lower contacts same as before, but to contact of first valve. It is sometimes necessary to screen this wire.

**AERIAL:** Rotor for upper contacts: same as before, but to fourth section of capacitor.

Rotor for lower contacts to aerial socket, or first to the IF trap and then to the socket.

As mentioned before, the coils are mounted in groups of three on each side of the wave-change switch with the intention of shortening the connections. Thus coil 1 is the 10-30 m coil, 2 the 16-50 m coil, 3 the 30-75 m coil, 4 the 75-200 m coil, 5 the medium-wave coil and finally 6 the long wave coil. It will be seen that the highest frequencies have the shortest connections, while the medium wave and the long wave coils are furthest away from the grid. (Fig. 4)

After having wired and finished the coil box, the whole assembly forms a compact unit with each compartment having only 4 outer connections:

*Contd. overleaf.*

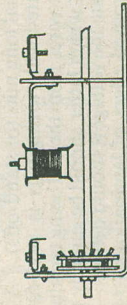

FIG. 7. CROSS SECTION THROUGH ONE COMPARTMENT

CS47

- (1) The grid rotor of the wave change switch to the capacitor,
- (2) The anode rotor of the switch to the anode of the respective valve,
- (3) The connection to the HT line,
- (4) The connection to the AVC line. (Fig. 7)

While the construction of the tuning-unit takes quite a lot of thinking and is somewhat complicated, the lay-out of the remainder of the set follows well-known principles. The different valves are screened from each other by aluminium screens below the chassis and by the well-known three-piece-type of valve screen for octal valves on top of it. The IF valves are mounted between the IF transformers, and these are securely bolted to the chassis. All capacitors and resistors are soldered as near to their valves as possible, while the return to earth is established by short wires to one or more tags on the fixing bolt of each valve. No screening should be used for any grid connections, but the main HT line and, if necessary, a few anode lines in the IF

### Useful Heater Transformer—

*contd. from P. 433*

the writer knows to his cost, for two hours painstaking effort are ruined in half as many seconds. For safety, tie up the bobbin with thin but strong twine; this can easily be cut away when most of the stampings have been built into the coil.

The stampings are built up, using a pair of T and U laid alternately over each other. Put a T through the coil from the right, with the corresponding U on the left, the next T being put in from the left and the U on the right and so on until the coil is packed tight. The last few T's will need a bit of persuasion, but it is best to get the coil packed tightly otherwise the core will "buzz" when the transformer is in use. The completed core should be tamped carefully, interposing between it and a hammer a piece of hard-wood to prevent damage to the edges of the laminations. When finished, all abutting edges of the laminations should be quite close, and the exterior of the core nicely levelled.

Fit the clamps on the core using screws and hexagonal long nuts (or stand-offs). A paxolin panel fitted with wiring tags is next fitted, the lead-out wires from the coil being terminated on the tags, which latter should be suitably marked to indicate the voltage it should deliver. Finally paint exposed edges of laminations to prevent rusting.

For the complete transformer, you will need just over 12 ozs of 24 swg enam., less than 4 ozs 18 swg enam., and just over 1 oz 28 swg enamelled wire, costing but a few shillings.

# PRACTICAL AERIALS

by "AETHERIUM"

## Part II

TV Feeders  
Directivity  
And Interference

### Television Aerials (Cont.)

Feeder values of 50 and 80 ohms are the standard ones used commercially today, most receiver input circuits being so flexible that the percentage of mismatch over the above figures is small. It is at the aerial itself that mismatching is so often apparent. The dipole, as stated previously, presents a reasonable match to 50 ohm feeder. When a close spaced reflector is added, the impedance falls to a much lower figure. With 0.15 wavelength spacing, it is, in fact, nearer to 25 ohms. This, in effect, means a standing wave ratio of 2:1. Apart from the standing waves causing reflections on the picture, this means a loss of signal strength additional to the loss figure of the feeder.

"Folding" the dipole as shown in Fig. 1 results in a step up of 4:1 in the impedance. With a close spaced reflector, therefore, the ideal method is to fold the dipole and feed with 100 ohm balanced feeder. The mismatch is negligible, balance is maintained, and losses are at a minimum. We find, however,

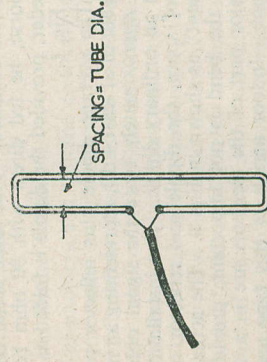

FIG. 1  
FOLDING A DIPOLE GIVES AN IMPEDANCE  
STEP-UP OF APPROX 4:1

C369

that our receiver has been designed for 50 ohm feeder, and not wishing to introduce a mismatch here, after all our trouble, we must devise a means to obtain a reasonable match. A length of 80 ohm twin feeder, used as a matching transformer, provides a satisfactory answer. A length of 4' for London, and 3' 3" for Sutton Coldfield will act as a matching transformer from the 100 ohm feeder to our receiver. This odd length comes about because all types of feeder, except air spaced ones, have a "velocity factor" or "K". Due to the polythene insulation, the wave "slows up" when passing through the cable, and a somewhat shorter length is required to produce the electrical effect of a quarter wavelength. Most makers of coaxial and twin feeders state the velocity factor, and this must be known before any attempt is made at calculations.

### Local Reflections.

It sometimes happens that a factory chimney or gasometer will produce a very bad reflection which no reflector or director will cure. An idea from America is shown in Fig. 2.

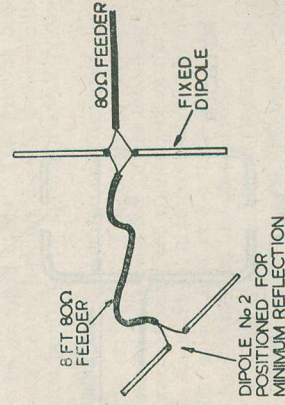
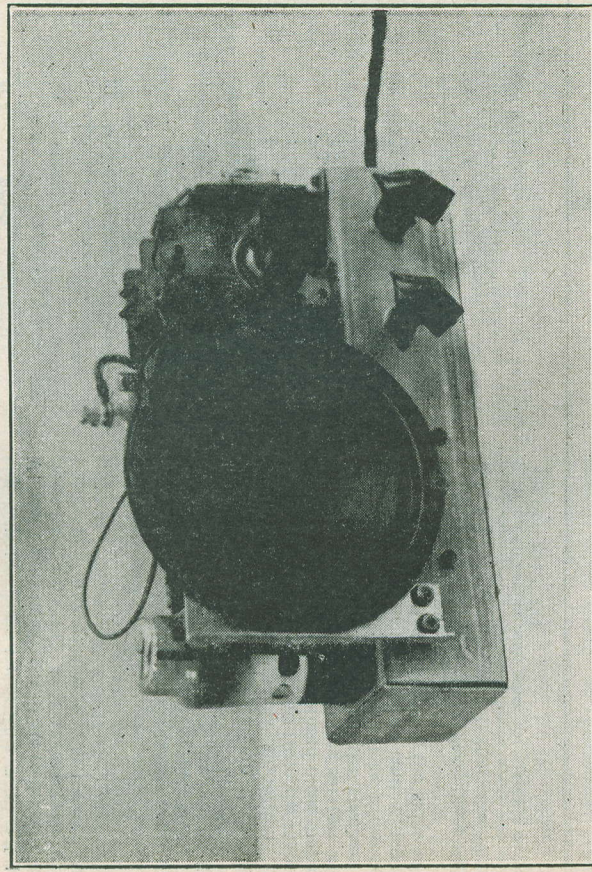

FIG. 2  
METHOD OF ELIMINATING REFLECTIONS  
FROM NEARBY BUILDINGS ETC.

C370

# The Constant Companion RECEIVER



## Part 3 By J. R. DAVIES

It may be found that the metal mounting ring of V2 valveholder bears too closely against the inside back of the chassis to enable it to be mounted easily. This may be overcome either by bending the ring down slightly at this point, or by cutting a small portion of it away.

The heater circuit is then connected up as shown in Fig. 1. The three-way line-cord is referenced "a", "b", and "c" in this diagram, the inset showing the connections at the plug end. In addition, a grommet should be fitted to the 1/2 inch hole at the back of the chassis through which the line-cord passes.

The heater wiring should be kept flat against the chassis. There is no necessity to take precautions against hum radiation from the volume control switch wiring, as this is at chassis potential when the receiver is switched on.

In last month's article we dealt with the process of making the chassis and its various appendages. We shall now carry on to the wiring of the receiver.

### Wiring the Heater Circuit

The valveholders and volume control may now be mounted on the chassis. Fig. 3 of last month's article illustrated the manner in which the valveholders should be installed. Using the Premier valveholders mentioned in the list of recommended components, it is important to have the metal mounting ring of the holders for V2 and V3 below the chassis; whilst that of V1 is kept above the chassis. This is essential in order to prevent congestion at the wavechange switch. A solder tag should be fitted under one of the securing nuts for the V1 valveholder its position being shown in Fig. 1.

Aerial is sometimes installed in high signal level areas, and installed with the reflector facing the interference centre, irrespective of the direction of the Transmitter. Sufficient signal will reach the receiver for satisfactory operation, and the interference level will be reduced to a minimum. Fig. 3 depicts a typical case.

### Reflector Spacing on "H" Aerials.

As mentioned previously, the reflector spacing affects the impedance (or radiation resistance) of the dipole. The approximate figures are:—

Spacing	Radiation Resistance.
0.1.	15 ohms.
0.15.	20 ohms.
0.2.	40 ohms.
0.25.	60 ohms.

From this, it will be seen that 1/3 or 1/4 wave spacing of the reflector will give the least

### IS YOUR AERIAL SAFE?

Why not be on the safe side, and insure it against possible damage to property or injury to others?

It may be that your landlord will not permit erection of an outdoor aerial because he has visions of damage to his property — if this is so, the fact that the aerial can be insured should go a long way towards changing his mind. Details of such insurance appear in an advertisement in this magazine, on page 455.

mismatch to 50 ohm feeder. The closer spacings of 0.1 and 0.15 provide slightly more gain, however, and increased directivity. Therefore, if using 50 ohm feeder for an aerial with a 0.15 spaced reflector, two lengths of 80 ohm feeder in parallel will act as a matching transformer. Lengths required are 4 feet for London frequency, and 3 feet 3 inches for Sutton Coldfield. This same aerial could, of course, be fed direct with 80 ohm balanced feeder, provided the dipole is folded as shown in Fig. 1.

The average dipole plus reflector provides a gain of at least 4 dB, representing an increase of approximately twice the signal obtainable on an ordinary dipole. For installation in a roof space, the dipole and reflector may be "bent" as shown in Fig. 4. The actual point of the bend is not important, provided the major part of the elements are in a vertical plane. Indoor aerials of this type are quite satisfactory, but it must be remembered that some loss of signal will occur, especially during wet weather, the wet roof absorbing or reflecting a certain amount of the signal.

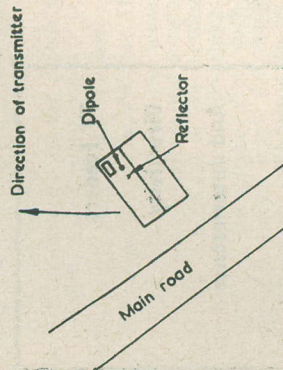

FIG. 3. "H" Aerial erected for minimum interference rather than maximum signal.

second dipole is connected with one wave-length (less the velocity factor) of feeder in parallel with the first, and used as a "phase changer". This movable dipole should be tried out in all positions, horizontal and vertical, until a position is found which begins to cancel out the reflections. It should now be carefully placed for minimum reflections, and most probably a position will be found where cancellation is complete. This will probably also result in a slight drop in signal level, but a slightly weaker signal with no reflections is far better than a strong one with objectionable images.

The standard "H" type Aerial is also useful in "steering clear" of unwanted reflections, although its main assets are in signal gain in areas of lower field strength, and in reducing interference from the rear. From the point of view of interference reduction, the "H"

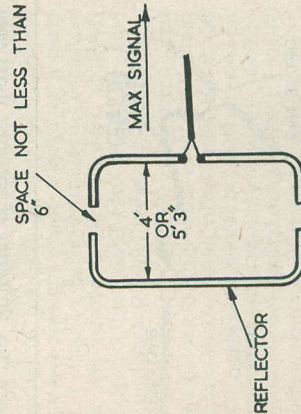

FIG. 4 BENDING AN "H" TYPE AERIAL FOR INSULATION IN ROOF SPACE



The set may now be temporarily connected to a source of supply (always remembering that the chassis may be "live") whereupon it should be found that the heaters of V1 and V2 are receiving approximately 6.3 volts each, and V3 20 volts. After the rectifier has warmed up it should be possible to obtain a DC HT reading between its pin No. 8 and chassis.\*

It will be noticed that pins 7, 8 and 1 of V1 are taken to chassis. This is done to save time later on. Pin 4 of the rectifier valve holder is a dummy and is used for anchoring purposes only.

**The Tagboard**

We may now mount our components upon the tagboard. Fig. 2 gives the layout. It will be seen that one side of the bottom tag components are taken to a communal tag, and thence, by a short lead, to the adjacent solder tag for their chassis connection. Fig. 2 also gives the connections from the tagboard to the remainder of the set and these may now be carried out as well, routing all the wiring through the space between the speaker and its recess. This wiring should be taken down the side of the tagboards and along the chassis to avoid its touching the sides of the rectifier or output valve.

**Fig. 1: Wiring the heaters.**  
The inset shows the circuit actually effected by the wiring.

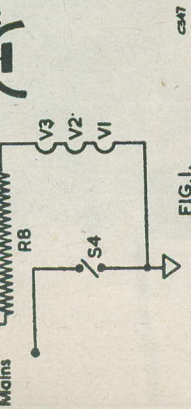
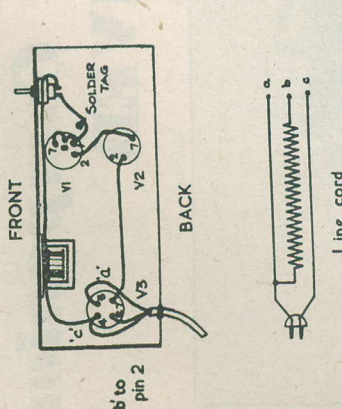

FIG. 1.

C347

lytic smoothing capacitor has been mounted.

**The Electrolytic Capacitor**

The electrolytic capacitor can next be fitted, it taking up the position shown in Fig. 3. It is necessary to provide a solder tag under the 4 BA nut which holds the electrolytic capacitor securing clamp to the back of the chassis. As the tags on the electrolytic capacitor are a little difficult to reach once it has been mounted, it is advisable to solder R6 and the two leads to its tags before it is fitted. One of the leads then goes to pin 4 of V2 (which forms an anchor tag for HT positive in the receiver) and the other to the unoccupied end of R7 on the tagboard. (See Fig. 3). The earth tag rivetted to the case of the electrolytic capacitor is not used.

**The Output Stage.**

We have now succeeded in wiring our smoothed HT to the screen-grid of V2, but we cannot check for HT as yet because the anode circuit of V2 is still open.

We therefore continue with the wiring of the output stage, Fig. 4 showing what is required. It is immaterial which side of the speaker transformer secondary is taken to chassis. (The voice coil is earthed, incidentally, to prevent any static HT being present on it due to the capacitance between primary and secondary of the transformer).

We can now check up our circuit to date. Firstly, however, we should ensure that the control-grid of V2 (top cap) is at chassis potential, and this we may do by connecting the grid temporarily to chassis via a resistor whose value lies between 100 and 500 kΩ. It also a good plan to take a quick check with an ohmmeter between HT positive and chassis to ensure that there are no accidental short circuits before switching on the power.

The receiver may again be connected to the mains and switched on. After the rectifier has warmed up there should be a voltage between pin 4 of V2 and chassis of roughly 180 volts; and another between pin 8 and chassis of 12 volts. When these points have been checked the receiver can be set right way up and tested for hum. If everything is working correctly no hum or, at worst, only a faint hum should be heard. If the grid of V2 is touched with one's finger a hum or similar disturbance, such as a click, should be heard in the speaker.

Readers may note that the writer advocates testing each part of the circuit as it is wired up. It is not necessary to do this, but it saves a considerable amount of trouble in the long run and locates any possible mistakes before construction is taken further. One has also the satisfaction of knowing, after

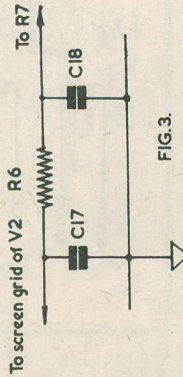
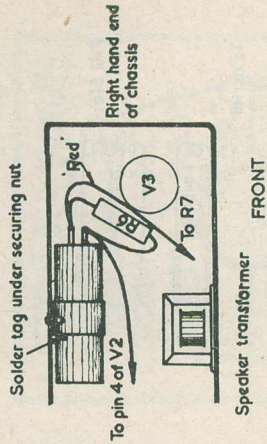

FIG. 3.

C348

**Fig. 3: Fitting the electrolytic capacitor.**  
each check, that what has been put in is in full working order.

**Modifying the Long-Wave Coil**

We have now advanced sufficiently far to start thinking about the detector. Before we can proceed with this stage, however, it

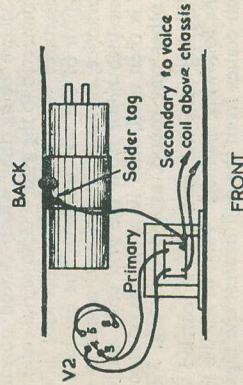

FIG. 4.

C349

**Fig. 4: Completing the wiring of the output stage.**

The set may now be temporarily connected to a source of supply (always remembering that the chassis may be "live") whereupon it should be found that the heaters of V1 and V2 are receiving approximately 6.3 volts each, and V3 20 volts. After the rectifier has warmed up it should be possible to obtain a DC HT reading between its pin No. 8 and chassis.\*

It will be noticed that pins 7, 8 and 1 of V1 are taken to chassis. This is done to save time later on. Pin 4 of the rectifier valve holder is a dummy and is used for anchoring purposes only.

**The Tagboard**

We may now mount our components upon the tagboard. Fig. 2 gives the layout. It will be seen that one side of the bottom tag components are taken to a communal tag, and thence, by a short lead, to the adjacent solder tag for their chassis connection. Fig. 2 also gives the connections from the tagboard to the remainder of the set and these may now be carried out as well, routing all the wiring through the space between the speaker and its recess. This wiring should be taken down the side of the tagboards and along the chassis to avoid its touching the sides of the rectifier or output valve.

**Fig. 2: Wiring the tagboard.**

One side of R7 is shown free, the wiring to this tag being carried out after the electro-

\* If on DC mains, only when the supply is connected the right way round.

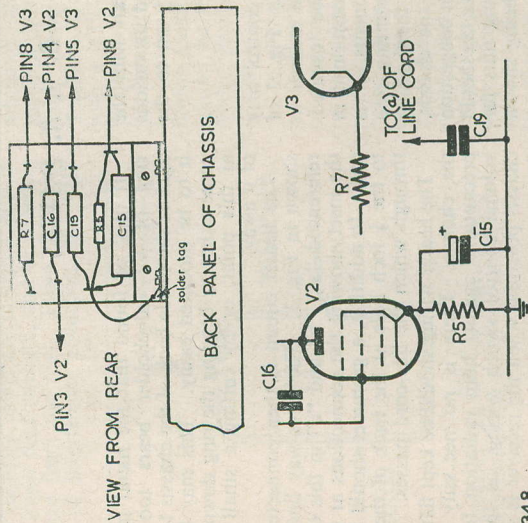

Fig. 2: Wiring the tagboard.

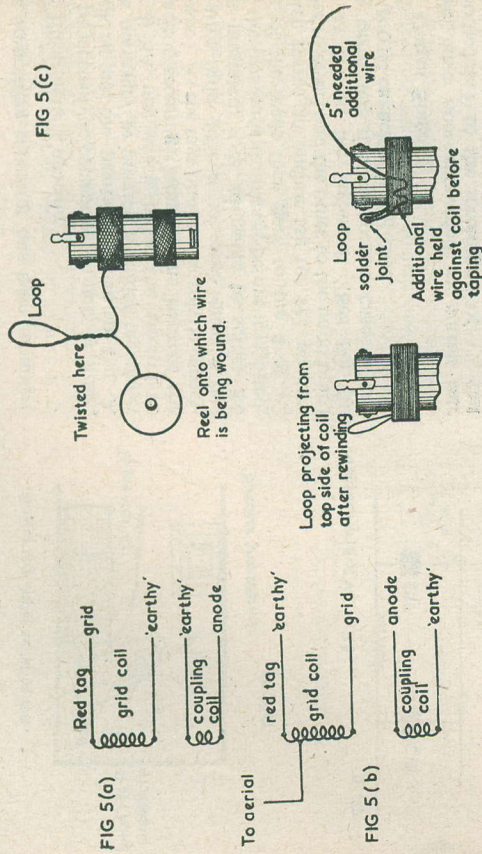

Fig. 5 (a): Circuit of P.A.1. coil, assuming that the coupling coil is used for reaction.

(b): How the aerial tap into the grid coil is carried out.

(c) (d) (e): Modifying the coil.

will be necessary to modify the coils and mount them on the chassis.

We start first of all with the long-wave coil (PA. 1). As manufactured, this has the circuit of Fig. 5 (a), the tag marked with a red sleeve being that which would normally be connected to the grid.\* Our aerial coupling necessitates us tapping into this coil about one-fifth of the way up from the earthy end. In practice, however, it is found easier to tap it one-fifth down from the grid end, and the coil is then used, with its windings connected the other way round, as shown in Fig. 5 (b).

Tapping into the grid coil is carried out in the following manner. First of all the lead which comes from the coil nearest the tags to the tag marked with the red sleeve is identified. This lead should come from the outside of the coil winding. The coil wire from the "red" tag is unsoldered and sixty turns are removed from the coil; all the time winding the removed wire onto a reel or similar object, since it has afterwards to be rewound on the coil again. A loop is then made in the wire by twisting it on itself after the sixtieth turn has been removed, as illustrated in Fig. 5 (c). The sixty turns are rewound on the coil again as neatly as possible, ensuring that sufficient of the loop projects from the side of the coil

\* We are assuming that the coil is being used in an oscillatory circuit.

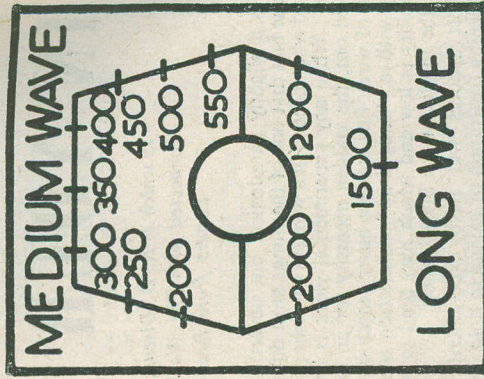

Ready Made Dial: This full sized dial will be found accurate enough for all normal purposes when used with any of the normal standard 500 pF gangs, and goes with the cabinet shown on the cover of the May issue. Constructional details of this cabinet will be given later in this series.

many turns for reaction purposes, some of these have to be removed; and secondly, another aerial tap is needed.

Removing the turns from the coupling coil is quite simple. First of all, the outside wire of the coupling winding (the bottom single coil) is identified and the wire unsoldered or broken away from its tag. 125 turns (this coil has a relatively large number of turns) are then removed from it, and the free end once more soldered to its tag.

Making the tapping into the grid coil needs a certain amount of dexterity, since the coil may be damaged if sufficient care is not taken. Fig. 6 (a) shows the appearance of the coil before modification, and it will be noted at once that the grid coil consists of four separate banks. The tapping is taken to the wire joining the two bottom banks. Fig. 6 (b) shows a detail of this wire and it may be seen that it travels from the inside of the bottom bank to the outside of the next. The coil is wound also (or was in several coils checked by the author) such that the wire travels to the top of the winding formation on the second coil before carrying on to the inside of the winding. Thus, if the wire is carefully pulled free of the paraffin wax holding it to the second bank for about 120 degrees or so, it will be found to come free enough to enable an easy solder joint to be made. After being pulled away, the insulation is scraped from the wire with a razor blade for about an eighth to a quarter of an inch. This wire consists of four or five thin enamelled strands and must be very carefully handled.

These strands are then tinned and a piece of thin wire (as with the long-wave coil) soldered to them. Care should be taken to see that all the strands of the coil wire are soldered and that none are broken. The additional wire is then anchored by winding insulating tape around the coil, the wire being kept well away from the coupling coil at the bottom of the former.

The writer has modified several coils in

this fashion using an ordinary 65 watt Solon with no extension bits, and has had no trouble at all. Nevertheless, it is a fairly "tuckish" job and, if one is a little uncertain about doing it, it is far better to get a friend to make the aerial tap connection than to perhaps spoil an otherwise serviceable coil.

Next Month.

In next month's article, we shall complete the wiring and carry on to the trimming of the reaction circuits.

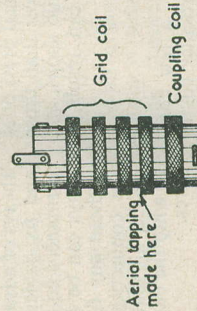

Fig. 6 (a): (b): Fitting the aerial tap to the P.A.2 coil.

FIG 6 (c)

FIG 6 (b)

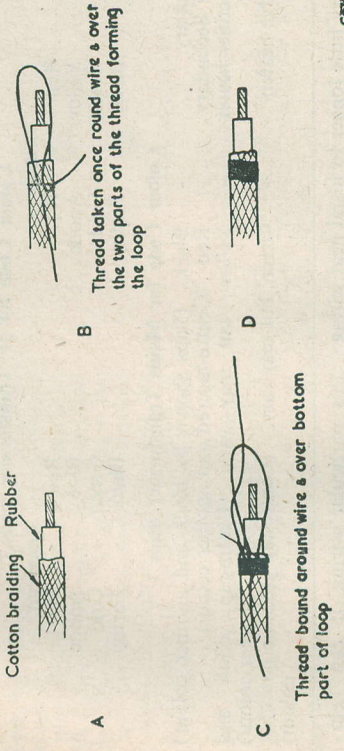

Fig. 1 : Successive steps in whipping the end of a wire.

in a length of thread and placed on the wire as illustrated in Fig. 1 (b). The thread is wound around the wire to the requisite length (Fig. 1 (c)) and its end is taken through the loop. The first end of the thread is next pulled out, causing the loop to pull the other end underneath the whipping. The two projecting ends are then cut off, giving the finished result of Fig. 1 (d). (While the thread at the final end is being pulled under by the loop, it can be held taut by holding it under a finger or between the teeth.) To complete the job and give it a nice "tidy" finish, the whipping can be painted with shellac varnish. After a little practice, a whipping such as this can be made in a very few seconds.

It often proves necessary to bind several leads together in order to form a harness. A simple and neat method of doing this consists of lacing the wires together. Fig. 2 shows an incorrect and a correct method of carrying out this process. The method of Fig. 2 (a) is incorrect because, should the thread break at any one point, the whole length will work free. In the second example, each section is held firmly, and a break at one point does not have any effect elsewhere.

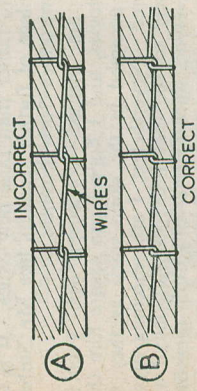

Fig. 2 : Incorrect method (a) of lacing wires together. The correct method is shown at (b).

**Chassis Wiring**  
The method of wiring a newly-built chassis is often very important if good results are to be finally obtained. It will usually be found, however, that the "wiring technique" used by home constructors noticeably varies from that employed by commercial manufacturers.

To a degree, this difference is functional and causes no variation whatsoever in the performance given by either type of chassis when completed. The commercial manufacturer has to design the layout of his wiring so that it may be reproduced quickly and cheaply by semi-skilled workers. His view is that, with small, domestic equipments, the question of neatness of wiring is not necessarily so important as that of economic fitting. With large chassis, (particularly with such things as communications receivers and industrial electronic gear) the reverse holds true and neatness of wiring is much more important because, apart from considerations of efficiency, this is one of the points of design which will be examined by prospective buyers.

The commercial manufacturer usually wires up his larger chassis with harness forms. These harness forms consist of wires previously cut to length, (also, perhaps, prepared for soldering), which are laced together in such a fashion that the various wires protrude at points corresponding to the tags to which they will eventually be connected. Very often some form of colour coding is used to facilitate making the connections.<sup>1</sup>

With amateur constructors the approach to wiring is usually quite different. So far as small chassis are concerned, it takes the

1. The most usually-encountered coding uses red for HT leads, green for grid and AVC circuits, black for earthy wiring, and black and white for LT and heater leads.

# IN YOUR WORKSHOP

In which J. R. D. Discusses Problems and Points of Interest connected with The Workshop side of our Hobby, based on Letters from Readers and his own Experiences.

IT is a slightly paradoxical but nevertheless true fact that one of the things most difficult to find when needed in a wireless workshop is—wire! When any experimental work is being carried out, the sudden necessity for an extra piece of wire often starts a hasty search which ends with a "bodge-up" connection whose reliability is low and which may tend to confuse the results of the investigation.

Most readers will have experienced the maddening frustration of having to hold up an interesting experiment simply because odd pieces of wire cannot be found; the annoyance being all the greater because the walls of the workshop are usually covered with wire which can hardly be pulled down to provide the few odd inches needed at the time.

When a lot of experimental work is envisaged, the constructor can hardly do better than buy half a dozen yards or so of cheap lighting flex simply for the purpose of wiring temporary circuits. The flex can easily be untwisted and cut to the lengths which are required and, when the circuit has been checked and stripped down again, the odd pieces of wire left over can be kept for future use.

It is also a good plan to lay in a stock of flexible screened wire, short lengths of which can be used over and over again.

Lighting flex cannot, of course, be used in such things as RF tuned circuits. In this case, a reel of tinned copper wire (say 18 swg or so) would prove invaluable. Insulated sleeving is also well worth keeping on hand; but the constructor should ascertain that he does not pay too much when buying this particular item. Several of the "postal" firms who advertise in the technical press offer sleeving at prices very much lower than those obtaining at some provincial radio shops, and a perusal of their catalogues can result in quite a useful saving in money.

### "Experimental" Connections

Some constructors who "tie" a few components together to check a particular circuit occasionally try to save time by twisting connecting wire around the solder tags of the various parts instead of making proper sol-

dered connections. In the long run, this process does not save time but actually wastes it. Apart from the unreliable results obtained from "crackly" connections that may sometimes have to be continually shaken to see whether a proper contact exists or not, there remains the possibility of damage to components and valves which could be caused by insecure leads falling away from their terminals and making contact elsewhere.

If, during experimental work, a soldering iron is kept constantly switched on, it will be found that the process of making quick soldered connections is actually swifter than that of twisting the wire around the various tags encountered. In addition there is the fact that the wire and the tags will, in many cases, have become well-tinned by previous usage, and so the time taken in making such connections becomes even shorter.

Some experimental workers advocate keeping not only a stock of uncut wire but also a supply of leads of various lengths, thicknesses and types; these leads being fitted with spade terminals, wander plugs, crocodile clips or any other wire terminations which may be required. The leads can then be used straightaway for almost any conceivable purpose. A comprehensive supply of leads such as this might not always be needed by the domestic experimenter; although the use of wires fitted with wander plugs for HT and GB batteries might help in cutting down the household expenditure on matches!

### Whipping and Lacing

Apart from temporary connections, it is always of advantage to know how to terminate and fix cables and wires which are used in permanent equipments. As most cables nowadays can be fitted to plugs and sockets, etc., without any further ado save that of making the connection and of fitting the clamping device, all that is really required is the ability to whip the ends of cotton-braided and similar wires.

To carry out this whipping, the wire should first of all be stripped in the manner shown in Fig. 1 (a). A loop should then be made

Colour Code for IF Transformer leads.<sup>1</sup>

British		American	
Red	HT +	Red	HT +
Yellow	Anode	Blue	Anode
Green	Grid	Green	Grid
Black	Earthy	Black	Earthy

Colour Code for Mains Transformer leads.<sup>2</sup>

Primary	-	Black.	(Taps shown by black and another colour)
HT Secondary	-	Red	(Centre-tap red and another colour)
Rectifier heater	-	Yellow,	but may vary. (Centre-tap yellow and another colour)
Valve heaters	-	Green,	but may vary. (Centre-tap green and another colour)

amateur very little longer to instal neat wiring than it does to use quickly fitted but untidy leads. Similarly, with newly designed larger chassis, the use of harness forms is rather difficult unless the whole layout has been carefully worked out beforehand. It often happens that chassis which are nearly finished require slight experimental alterations before they can finally be considered complete, and the use of a wiring harness does not always allow such alterations to be easily made. Nevertheless, HT and LT leads, etc., should not have to be altered once the chassis has been wired up; and, if the constructor is prepared to go on to the trouble of making up a harness for

this particular wiring, it can help towards giving a very neat and professional-looking job.

## Colour Coding

Certain components which have lead-out wires instead of connecting tags often use a colour code to differentiate the wires. A table showing the more commonly-met codes for IF and mains transformers is published with this article.

1. Almost all IF transformers will use red for "HT +", and green for "grid", even if the other colours vary.
2. Mains transformers should be checked with an ohmmeter before connecting up.

## Magnetic Recording

A LIMITED NUMBER OF ISSUES COVERING THE COMPLETE SERIES OF ARTICLES BY PAXE ARE NOW AVAILABLE. OBTAINABLE FROM YOUR USUAL SUPPLIER OR DIRECT FROM US.

from our



Mailbag

## Tone Control Circuit.

Dear Sir,—I expect we shall soon be seeing the Editorial footnote "This subject must now be closed" if Mr. French and I keep at it much longer, if only for the reason that readers might think that I am seeking to deny his amplifier circuit as one that won't work at all, quite apart from the little argument about tone control circuits within FNB loops!

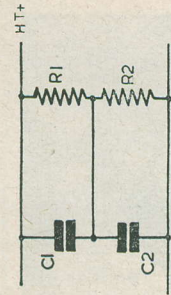

MBS

Some method of voltage regulation is obviously needed, the simplest form being a potential divider.

In the diagram, C1 and C2 are smoothing capacitors in series. The potential divider R1 and R2 acts as the voltage corrector. The resistances of R1 and R2 are such that the voltage developed across each of them does not exceed the working voltage of their respective capacitors. The overall resistance of R1, R2 should be as low as can be permitted (considering the amount of current which may be taken from the power supply without overload) to ensure good voltage regulation. The resistors should never be of such high value as to be affected by the parallel leakage resistance of their capacitors.—J. Glazer (Westcliff-on-Sea).

However, Mr. French has proved his point and I accept it. As I prefer to state a relative gain as plus dB and a relative attenuation as minus dB, I hope he will return the compliment and accept that as true. Whatever else it has done, I feel that the discussion has provoked healthy debate, and shown readers that the Editor is prepared to open his columns to technical wrangles concerning material published in his journal. Thank you, Sir! Mr. French... my hand!—W. E. Thompson (St. Leonards-on-Sea). (Gentlemen, you've now 'had it'! Next, please!—Ed.)

## Capacitors in Series

Dear Sir,—There seems to be a great many ideas on connecting capacitors (especially of the smoothing type) in series to increase the overall working voltage. The voltage developed across each of these is dependent upon the resistance of their leakage, and by Ohm's Law the greatest voltage will be developed across the capacitor with the highest leakage resistance.

This capacitor will probably break down if the voltage across it exceeds normal. In the event of this happening, the other capacitor in series with it will receive nearly 100% overload.

TAMSA

## Tape &amp; Wire Recording Components

Write for latest price list of the following:—

RECORD, PLAYBACK & ERASE HEADS. THE NEW TAMSA HEAD RANGE ARE NOW AVAILABLE: RECORD PLAYBACK AMPLIFIERS OSCILLATOR COILS & UNITS TAPE E.M.I. WIRE on standard 1, 1/2, 3/4, and 1hr G.E.C. DUREX Spools.

Constructor's Envelopes  
Books on Tape Recording

Manufactured by:—

AUDIGRAPH

Dept. M.R.8, 74 Great Hampton Street, Hockley, Birmingham. 18. 5460D

## CLYDESDALE

Bargains in Ex-Services Radio & Electronic Equipment

**COMMAND TX. FOR CONVERSION.**  
5.3 to 7 Mc/s Command Tx. Chassis, complete except for coil winding and valves.  
An excellent basis for a V.F.O. or portable Tx. All other components and wiring intact.  
Enclosed in a louvered metal case, with calibrated S.M. dial.  
CLYDESDALE'S  
PRICE ONLY. 15/- POST PAID.

## U.S.W. TRANSRECEIVER.

This unit consists of two separate chassis,—the first mounts a 3 valve transreceiver operating at about 70 Mc/s. A few of the amplifier valve components have been removed—and chassis is less valves.

All other circuits are intact and on the second chassis a 3" speaker, switch and phone jack, are mounted. Enclosed in a large black cracked cabinet 19 X 17 1/2 X 6" approx. with two silver finished front panels.  
CLYDESDALE'S  
PRICE ONLY. £2 10 0d. CARRIAGE PAID.

Order Direct from:—

CLYDESDALE SUPPLY CO., LTD.

2, BRIDGE STREET, GLASGOW, C.5.  
Phone: SOUTH 2706/9  
Branches in Scotland, England & Northern Ireland

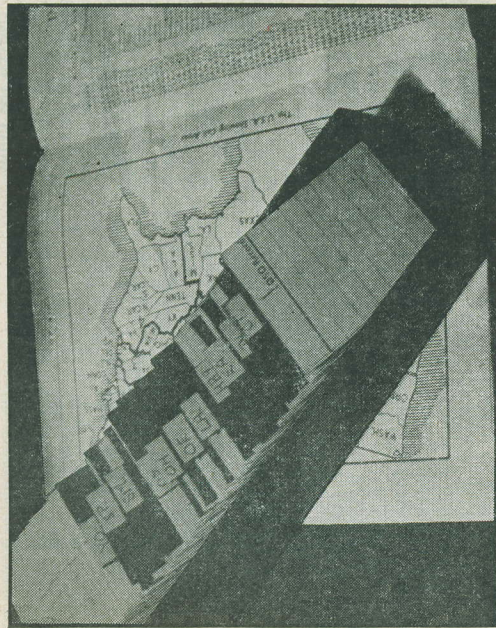

## Useful Accessories

## 'Minicard' Record Cards

QSO and STATION RECORD CARDS 2½ in. x 2¼ ins. printed both sides, available for either Amateur or Broadcast Station records, at 2/9 per 100 post paid. Metal filing trays as shown, heavy gauge steel, green enamel to hold 500 cards, 2/9 post paid.

from—  
A.S.W.P.  
57 Maida Vale  
Paddington  
LONDON, W.9

Do you value your . . .

## TELEVISION SET?



Do you realise that you could be held responsible if your SET or your AERIAL caused injury or damage?

A "SCOTTISH" policy will cover damage to your TELEVISION SET, your liability for injury to Third Parties, and damage to your own property by the aerial FOR AS LITTLE AS 7/6d. A YEAR!

**Scottish Insurance Corporation Ltd.**  
62/63 Cheapside, London, E.C.2,

Have **YOU** seen

THE NEW

## Short Wave News

Extra pages, modern attractive cover, crammed full of articles of interest to the short wave enthusiast—Constructional articles, topical features, amateur and broadcast band news, as well as much other information.

**PRICE 1/6**

From your bookseller or direct from us.

**AMALGAMATED SHORT WAVE PRESS, LTD.**

57, Maida Vale, London, W.9.

## METAL WORK

with a difference!

If you want a well-made, attractive and robust cabinet for that receiver or transmitter; if you need a chassis for a modulator, amplifier or converter; in fact, if you need any metalwork at all for your ham requirements

**YOU CAN DO NO BETTER THAN TO WRITE US FOR AN ESTIMATE**

All metal work "made to measure"

For full details and address of nearest agent, contact—

**L. J. PHILPOTT (G4BI)**  
(E. J. PHILPOTT)

Chapman St., Loughborough  
Telephone: 2864

## PANEL TRANSFERS

Amateurs!

. . . Take Note

Here is your chance to "finish" that new Rig of yours.

Available for the first time in this country is a range of over 100 Panel Marking Transfers on one sheet, suitable for most Amateur Receivers, Transmitters, Modulators and Power Packs etc.

These are attractively printed with silver lettering on a black background.

**Price per sheet is 2/6d. inclusive of postage.**

Terms Cash with Order.

For further details, write enclosing S.A.E. to:—

**K. NORVALL G3666**

**C/o., H. NORVALL & SONS LTD.,**  
5, Torrains Street, City Road, London, E.C.1.

## THE MODERN BOOK CO.

Wireless Coils, Chokes & Transformers by F. J. Camm. 6s. Postage 4d  
Loudspeakers by G. A. Briggs. 5s Postage 4d.

Practical Wireless Service Manual by F. J. Camm. 8s. 6d. Postage 6d.

Sound Reproduction by G. A. Briggs 10s. 6d. Postage 6d.

Practical Wireless Encyclopaedia by F. J. Camm. 21s. Postage 9d.

Wireless World Diary 1951. 3s. 8d. Postage 2d.

Valve & Service Reference Manual 5s. Postage 4d.

Radio Tube Vade-Mecum 1946 edition by P. H. Brans. 2s. 6d. Postage 6d.

We have the finest selection of British and American radio books in the Country.  
Complete lists on Application.

**19-23 PRAED STREET, (DEPT.) LONDON, W.2**

PADddington 4185.

### SMALL ADVERTISEMENTS

Readers' small advertisements will be accepted at 2d. per word, minimum charge 2/- . Trade advertisements will be accepted at 6d. per word, minimum charge 6/- . If a Box Number is required, an additional charge of 1/- will be made. Terms: Cash with order. All copy must be in hand by the 12th of the month for insertion in the following month's issue.

**PRIVATE**

**EDDYSTONE 640**, matching speaker. £17. RF26, 35/- . A1 Freemachine with drilling attachment. £5. 15. 0. All mint condition.—Dean, 99 Fairfield Street, Bramley, Leeds, Yorks.

**RSGB "Bulletins"**, 1941 to 1949 in bound volumes. 25/- each.—Box B160.

**TELEVISOR**, Premier, VCR97, cabinet, magnifier, £20. Needs alignment and time base adjustment.—Wilson, 35 Keslake Road, Kensal Rise, London N.W.10.

**WANTED**. Constant voltage transformer, 230V output. Please state price. Box B159.

**CARBON PILE VOLTAGE REGULATORS**, Regulate up to 80V. Large numbers or single units supplied. 12/6 each. Apply: Stokes, Clotton, Tarncliffe, Cheshire. Tel. 30.

**HRO FOR SALE**. 50 kcs to 30 Mcs. Power pack.—Box B158.

**R1116A**, with mains power pack and speaker, good condition, £6. 10. 0 or offers.—R. Huntsman, 2, Lincoln Terrace, Hexham, Northumberland.

**WANTED**. Circuit diagrams of Receiver R1137A, Driver 5001A, Control Unit 5008, Modulator 5001A, Power Unit 5008/9, WS—19. Also valves: 3 x 3C24, 2 x 811. Write first stating price.—4 Mellor Road, Western Park, Leicester.

**VCR97** with base and mask. As new—less than 2 hours use.—Box B161.

**SALE R1116A** double superhet, battery, 15—2500m. £5 or exchange.—C. Hawkins, 26 Commercial Street, Church, near Accrington, Lancs.

**MUST SELL**. Power pack and partly built 10 watt amplifier. SAE for details.—J. Powley, 134 Fernie Park Road, London, N8.

**HALLICRAFTERS SX28**, new 0.55 to 43 Mcs. 15 valves, BFO, bandspread, crystal phasing control, AC, DC and 6V Battery. With spare valves and instruction book. £50. CZERNIAK, 60, Elmwood Road., SE24.

**TRADE**

**FLEX. SUPER QUALITY**. Aero Intercom Leads, containing 4 lengths—approx. 24ft—two screened, 2s. each, five for 10s. post free. L.T.S. Ltd. "Bromyhurst", Barton Road, Urmston, Lancs.

**E.M.**

**JOB or HOBBY**—Whichever it is in Radio or Television, we can help you. Backed by the great E.M.I. organisation, we can offer the most authoritative and up-to-the-minute Home Study courses in Radio, Television and Electronics. **FREE BROCHURE** from E.M.I. INSTITUTES, Postal Tuition Division, Dept. R.C.11, 43, Grove Park Road, Chiswick, London, W.4. Chiswick 4417.

**NEOSID VHF Coil Formers**, Dust Cores, etc. (see RADIO CONSTRUCTOR, 2 metre Converter, June issue) Johnsons (Radio) 46, Friar St. Worcester.

**"GLOBE KING"** Amateur SW Radio Kits from 25/- Write for interesting Free Literature and Catalogue (enclose stamp for postage) Johnsons (Radio) 46, Friar Street, Worcester.

**BLUEPRINTS** complete with instructions **SWN SW One-Valve** battery driven, using DF91 valve. "Perit-TRF" circuit. **High Gain 10 Metre Converter**, with a de-luxe circuit, comprising EF91 RF stage, EC99, with stabilised voltage supply via a 7475. 1s. 8d. each post free from A.S.W.P. 57 Maida Vale, London, W.3.

**High Gain 10 Metre Converter**, with a de-luxe circuit, comprising EF91 RF stage, EC99, with stabilised voltage supply via a 7475. 1s. 8d. each post free from A.S.W.P. 57 Maida Vale, London, W.3.

**USE THIS FORM FOR SMALL ADVERTISEMENTS**

Terms cash with order. Payment should be made either by P.O., M.O. or cheque, crossed and made payable to AMALGAMATED SHORT WAVE PRESS LTD.

**'RADIO CONSTRUCTOR'**

**PRIVATE RATE PER WORD**  
Minimum 2/-

**TRADE RATE PER WORD**  
Minimum 6/-

**ADCOLA**  
*(Regd. Trade Mark)*  
**SOLDERING INSTRUMENTS**



Reg. Design No. 860302  
*(British, U.S. and Foreign Patents)*  
Designed for wireless assembly and maintenance. Supplied for all volt ranges from 67v to 230/250v. High Temperature, Quick Heating, Low Consumption, Light Weight.  
3/16" Dia. Bit Standard Model 22/6  
1/4" Dia. Bit Standard Model 25/0  
3/16" Dia. Detachable Bit Type 30/0  
Sole Manufacturers: **ADCOLA PRODUCTS LTD**  
General Offices and works: Cranmer Court, Clapham High St., London, S.W.4. (MAC 4272)

● 1951 EDITION  
**THE RADIO AMATEUR'S HANDBOOK**  
Published by the A.R.R.L.  
Price 22/6 postage 1/-  
**THE MODERN BOOK CO.**  
19/21, Praed Street, London, W.2.  
Tel.: Paddington 4185 Dept. RC

introducing . . .  
**"PANL"**

"PANL" is an air drying crackle finishing enamel, which may be brushed or spray applied, no special precautions being needed.

"PANL" dries with a black crystalline gloss, and gives that professional finish to chassis, panels, etc.

"PANL" gives a new look to old equipment.

"PANL" is obtainable from your local radio parts dealer.

**QUALITONE PAINTS LTD.**  
10-14 Mitford Rd., London, N. 19.

- VALVES.**  
6V6G, 6V6GT, 5Z4M, 1T4, 354, 1S4, 1R5, 1S5, 78, FW4/500, 6F6, 5U4, 6X5, VU39, 6C6, 6D6, VR150/30, 42, 80, 1C5, OZ4, PEN46, 25A6G, 82, 25L6G. **ALL AT 9/- each.**  
KT66, 807, 6L6, KT33C. **AT 11/- each.**  
707, 6B8, 6MS/PEN, EK32, 12SH7, 12H6, 12A6, 6N7GT, 6AG7, 6B8, 6C5GT, 6E6, 6K6, 6L6, 6N6, 6Q7, AC6PEN, EF39, EF36, EL32, 77, 41, 65K7, KT24, MH41, EBC33. **ALL AT 7/- each.**  
VU111, CV73, 37, 615. **ALL AT 4/6 each.**  
VUI20, 2155G, 2X2, PEN220A, CV9, SP41, 6H6, EB34, SP61, DK510, VS68, 2051, HD24, RK 872. **ALL AT 4/- each.**
- SPEAKERS:**  
5" Goodman P.M. 2/3 OHMS. 13/6 each.  
6" Truvox P.M. 2/3 OHMS. 13/9 "  
8" Plessey P.M. Lightweight 2/3 OHMS. 13/6 "  
**METAL RECTIFIERS:**  
L.T. 2 V. 1/2 amp. 5/- each.  
L.T. 12 V. 60 M/A. 1/- "  
H.T. 280 V. 60 M/A. 4/6 "  
**VOLUME CONTROLS.** 1/6 each.  
2K OHMS. 3K, 25K, 5K, LESS SW. 4/6 doz.  
**MOULDED MICA CONDENSERS.**  
.0001, .0002, .0003, .001, .0004  
Bell Push with warning light, numerous uses, ideal for offices. 1/6 each.  
**SPECIAL OFFERS:** Single strand 24 SWG. P.V.C. various colours, 1000 ft. 15/-, Midget choke 150 ohms. 2/6d. Phillips type choke 80 M/A 5/-, Headphones low resistance 5/6d.  
B.I. ALL WAX CARTON. 4 MFD. 500 V. 2/6 each.  
4 x 4 MFD. 500 V. 3/4 "  
4 x 8 500 V. 3/9 "  
POST ORDERS ONLY. C.W.O. OR C.O.D. SEND 2d. stamp for most comprehensive list in trade. Carriage paid over £2.
- ALPHA RADIO SUPPLY CO.**  
1, Vinces Chas. Victoria Square, LEEDS 1.

### Building a Televator?

**THEN CONSIDER THE FOLLOWING**

**RECEIVER R1355**, as specified for "Inexpensive Television", complete with 8 valves VR65 and 1 each 5U4G, VUI20, VR92, also a copy of "Inexpensive TV," ONLY 55/- (carriage, etc., 7/6). Copy of book only 2/6.

**I.F. STRIP 194**. Another of the units specified as an alternative for the "Inexpensive TV." A first-class strip giving tremendous amplification, and well recommended for constructors who have built televisions but have come "unstuck" in the vision or sound-receiver. Complete with 6 valves VR65, and 1 each VR53 and VR92, and a copy of the book, which gives full details of conversion to both stations. Size 18in. x 5in. x 5in. ONLY 45/- (postage, 2/6).

**"PYE" 45 mc/s. I.F. STRIP**. Ready made for London vision channel. Complete with 6 valves EF50 and 1 EA50. ONLY 60/- (postage, etc., 2/6).

**RECEIVER R3547**. This contains the "PYE" Strip, which can be easily removed if desired, and also 15 valves EF50, 3 of EB34, 2 of SP6, and 1 each EA50, EBC33, EF36, also hundreds of resistors, condensers, etc.—BRAND NEW IN MAKERS' CASES. ONLY 120/- (carriage 7/6).

Cash with order, please, and print name and address clearly.

**U.E.I. CORPORATION,**  
The Radio Corner, 138, Gray's Inn Road, London, W.C.1.  
(Phone TERMINUS 7937)  
Open until 1 p.m. Saturdays. We are 2 mins. from High Holborn. 5 mins. by bus from King's Cross.